

*LT&B*

# FRESHAIR

*I am Protected*

USER'S MANUAL

Installation | operation | specifications | features | maintenance



Designed and tested  
California, U.S.A.









## CONTENTS

---

Specifications.....	2
Introduction.....	2
Your New FreshAir by LT&B .....	3
Inspection & Installation.....	3
Unit Features.....	3
Operation.....	4
Placement of Unit.....	4
Settings & Adjustments.....	5
LCD Display.....	5
Maintenance Reminders.....	6
General Maintenance.....	6
Removing the Rear Lint Screen.....	8
Installing the ActiveOx (PCO) Cell & Purifier Plate....	9
Removing the Purifier Plate & ActiveOx (PCO) Cell...8	
Installing the Rear Lint Screen.....	9
Troubleshooting.....	10

## WARNINGS

---

-  **WARNING!** Do not operate this unit without the rear lint screen AND back cover installed.  
.....
-  **CAUTION!** The AWAY Mode feature of this unit is to be operated in unoccupied areas only.  
.....
-  **CAUTION!** Disconnect the power cord before servicing.  
.....
-  **CAUTION!** Use extreme caution when using any appliance around children, the elderly or people with disabilities and whenever the unit is operating unattended.  
.....
-  **CAUTION!** Keep the unit out of reach of children.

## INTRODUCTION

---

Congratulations! You have purchased one of the most effective, technologically advanced air purifiers! Your new FreshAir by LT&B is designed to provide years of trouble-free, low maintenance operation. Be sure to read and follow all service procedures outlined in this owner's manual, and use only genuine replacement parts.

## SPECIFICATIONS

---

### Electrical:

- Input: 100 - 240VAC 50/60Hz 2.5A
- Output: 38V DC 1A
- 38watts power consumption
- 24 to 30 KW, 20-30 Khz ion generation pulsator
- Fixed 6.5 KW DC needle ion generator

### Size:

- Dimensions:
- 12" high x 9" wide x 12' deep
- Weight: 16 pounds

**Trioxygens (PCO) cell Output (Normal Mode):**  
< 0.02ppm (ambient room concentration)

**Purification O<sub>3</sub> Plate Output (High Mode):**  
0 - 360 mg of trioxygens

### Cover:

Covers a range of 250 ft<sup>2</sup> (23 m<sup>2</sup>) to 3000 ft<sup>2</sup> (279 m<sup>2</sup>)

\*\*depends on variables such as severity and frequency of pollution, humidity, and temperature.

## YOUR NEW FRESHAIR BY LT&B

---

- Eliminate smoke, odor and tobacco smoke.
- Includes (PCO) Technology, which incorporates the same process used to scrub the air inside spacecraft.
- Germicidal, broad spectrum, high-intensity UVX lamp (100 - 300nm).
- Removes odors from your home, office, car, boat, RV, etc.
- Improves the quality of air indoors, up to 3000 ft<sup>2</sup> (279 m<sup>2</sup>).
- Customizable to your environment, using either the included remote or the controls on the front of the unit.
- FreshAir alerts you when normal maintenance needs to be performed or service required.

## INSPECTION & INSTALLATION

---

1. Remove protective packaging.
2. Remove unit from the shipping carton.
3. Remove all protective materials.
4. Check for shipping damage and loose or broken parts.
5. Read the Owner's Manual thoroughly prior to installation.
6. Install batteries in remote.
7. Determine placement location for the unit (See "Placement of Unit" on page 4). Plug the unit into a working electric outlet.
8. Using either the remote control or the Power Button, turn the unit ON.

## UNIT FEATURES

---

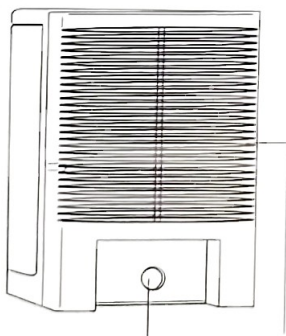
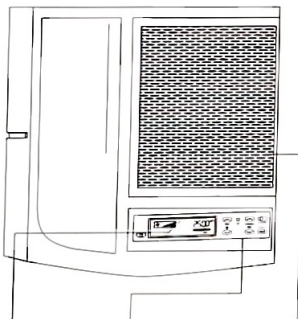

Power Cord Receptacle      Back of Unit/  
Rear Access

- LCD Display
- Controls
- Removable Grill
- Power Cord Receptacle
- Back of Unit/Rear Access
- Exclusive PCO Technology
- NeedlePoint Ion Generation
- Five Speed Fan
- Adjustable Purifier Control (High Mode only)
- LCD Display
- Away Mode Function w/Adjustable Digital Timer
- IntelliAir Maintenance Reminders
- Remote Control or Manual Operation
- Computer Style Cord
- Uses Standard Household Current
- Washable Purification Plate
- Washable Rear Lint Screen
- Replaceable PCO cell

## OPERATION

1. Adjust the fan speed to your preference, keeping in mind that higher fan speeds will give better results.
2. Using the Normal/High button, set the unit to NORMAL, for typical use or HIGH for increased smoke and odour control.
3. For HIGH MODE, using the PURIFIER UP and PURIFIER DOWN buttons, adjust the purification level to its lowest setting (250 ft<sup>2</sup> (23 m<sup>2</sup>)) for the first 24 hours of operation, then gradually adjust up (if needed) to the square footage (or square meters) of the indoor area.

If you are operating your central heating and air conditioning fan, or other ventilation system, continuously, set the coverage up to the total ventilated indoor area. Otherwise, set the coverage up to the size of the room. Do not exceed the size of the ventilated indoor area when setting the purifier level.

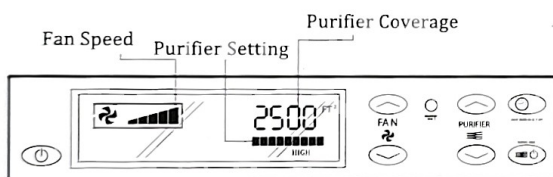

**HIGH MODE:** The unit's display shows the fan speed (low to high) the purifier setting (1 bar to 12 bars) and the purifier coverage in square feet, for U.S. models, and square meters, for international units.

4. To operate the AWAY MODE feature, in unoccupied areas only\*, press the Away Mode button until the desired time is reached (2, 4, 5 or 8 hours). The unit will display AWAY MODE and the remaining time. To interrupt the AWAY MODE, press the Normal/High button.

\*Please note: "unoccupied areas" include pets. Some pets, like humans, may experience adverse reactions from exposure to increased levels of O<sub>3</sub> and should not be present during AWAY MODE operation.

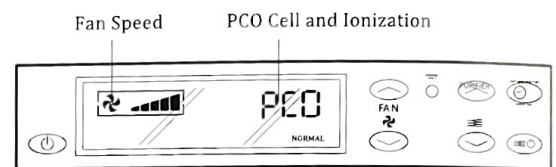

**NORMAL MODE:** The unit's display shows the fan speed (low to high) and NORMAL to indicate that the PCO cell and ionization are both functioning normally.

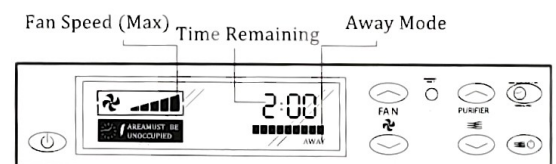

**AWAY MODE:** The fan will show maximum, and AWAY MODE will replace the purifier setting. The amount of time remaining will depend on how long you have selected for the AWAY MODE function to operate. The colon (:) will flash to indicated time being counted down

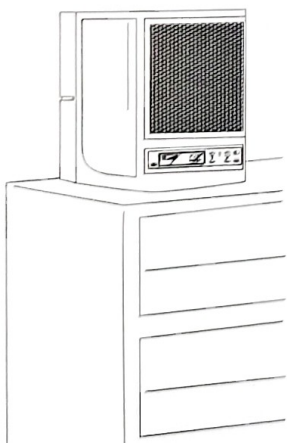

### Note:

- The rear of the unit should always have at least one inch of open area to allow unrestricted airflow.
- Point the unit towards the center of the room for maximum dispersion of ions.
- To prevent injury, be sure the power cord is not accessible to small children.

Place the unit as high as possible to ensure complete purification. (On top of a bookshelf, high cabinet, etc.)

Suggested locations listed in the order of preference:







1. Nearest the source of the worst pollution.
2. Near a cold-air return to thoroughly circulate the benefits of your FreshAir by LT&B throughout the area.
3. In the area most heavily used to achieve maximum benefit.



## SETTINGS AND ADJUSTMENTS

FreshAir by LT&B can be turned on or off, and adjusted using either the included remote or the control panel on the front of the unit. With the exception of Reminder Reset button, both the remote and the control panel buttons have the same functions.

If you are operating your central heating and air conditioning fan, or other ventilation system, continuously, set the coverage up to the total ventilated indoor area. Otherwise, set the coverage up to the size of the room. Do not exceed the size of the ventilated indoor area when setting the purifier level.

- |  |  |
|--|--|
| <p> <b>POWER (standby)</b><br/>Turns the unit ON and OFF.</p> <p> <b>Fan UP/Fan DOWN</b><br/>Adjusts the five speed fan.</p> <p> <b>Purifier Up/Purifier Down (high mode only)</b><br/>Works when the unit is in High Mode to set the indoor<br/>The level is indicated by both a horizontal bar graph and square footage (U.S. models) or square meters (international models). The unit will switch to Normal Mode, if the PURIFIER DOWN button is pressed when the square footage is set to 250 ft<sup>2</sup> (23 m<sup>2</sup>).</p> <p> <b>Sleep Mode</b><br/>Turns on/off LCD backlight</p> | <p> <b>NORMAL/HIGH</b><br/>Toggles the unit between Normal Mode (PCO and Ionization) and High Mode (PCO, Ionization and Purification Plate).</p> <p> <b>Away Mode</b><br/>Turns on and adjusts the timer for the Away Mode function. Each press of the Away Mode button will increase the time by two hours, up to eight hours, then OFF. The AWAY MODE should be operated in unoccupied areas only.*</p> <p> <b>Reminder Reset (control panel only)</b><br/>Clears the maintenance reminders after performing routine maintenance.</p> |
|--|--|

\*Please note: "unoccupied areas" include pets. Some pets, like humans, may experience adverse reactions from exposure to increased levels of O<sub>3</sub> to increased levels of O<sub>3</sub> and should not be present during Away Mode operation.

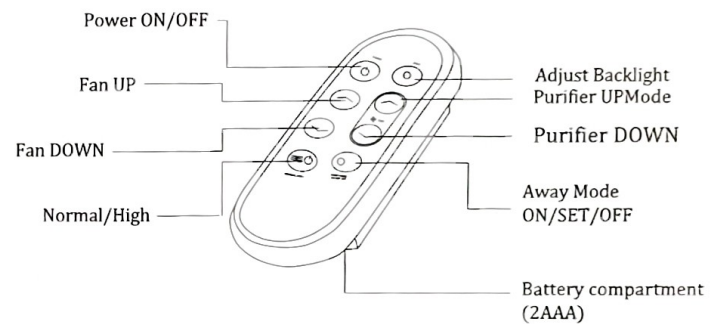
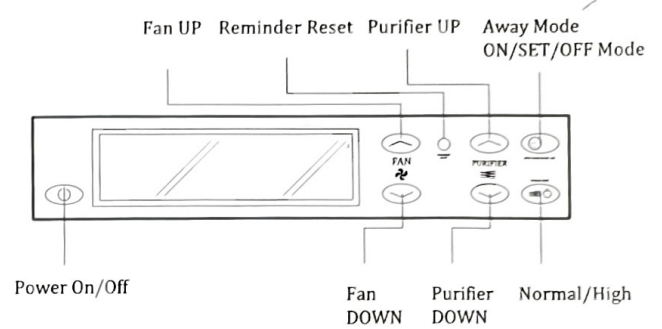

### LCD DISPLAY

The LCD Screen is used to display all current setting) see page 4 as well as any maintenance reminders.

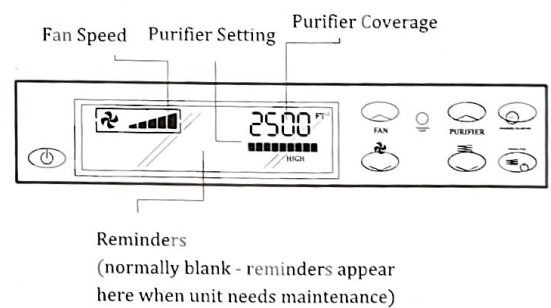

### LCD SCREEN BACKLIGHT

As the adjustments are being made, the LCD screen backlight will brighten and the settings on the screen will change. After 3 seconds, without change, the backlight will return to normal.

If a maintenance reminder or a service reminder appears, the backlight will brighten and stay bright until the Reminder Reset button is pressed or the services corrected.

## MAINTENANCE REMINDERS



### REPLACE PLATE

The purifier plate is not functioning properly.

- Replace the old purifier plate with a new purifier plate.

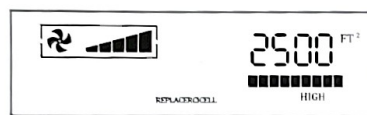

### REPLACE PCO CELL

The PCO cell is no longer working correctly.

- Replace the PCO cell.
- Please Note: the PCO cell should be replaced every two (2) years, even if the unit does not display this message.



### PERFORM CLEANING

(approx. every 30 days)

- Clean the rear lint screen (see page 6)
- Vacuum the PCO cell
- Clean the purifier plate (see page 7)
- Vacuum front and rear grill openings

### RESETTING THE REMINDERS

The only reminder you need to reset is the PERFORM CLEANING reminder (after performing maintenance, press the Reminder Reset button and the screen will momentarily display CLEARED to let you know the reminder has been cleared). All the other service reminders will clear automatically once the unit has been turned off and back on and the problem has been corrected.

## GENERAL MAINTENANCE

Periodic maintenance is required to ensure that your FreshAir by LT&B operates properly. The unit will display a PERFORM CLEANING reminder when it's time to perform regular maintenance. If you are operating your unit in a severely polluted environment, cleaning of the unit, purifier plate, PCO cell and rear lint screen should be done more frequently. Shown here are basic procedures that should be carried out to keep your unit running at top performance. For optimal performance, and to prevent damage not covered by your warranty, install the optional FreshAir purifier pre-filter. Failure to perform routine maintenance could adversely affect the proper function of the unit or cause it to fail prematurely.

Note:

If a unit is returned for repair, and it is determined that neglect of the unit or unauthorized tampering with any mechanical or electronic component of the unit caused the failure, LT&B reserves the right to void the product warranty. This will require the owner to pay for any required repairs.

### CLEANING THE CASE:

Wipe the unit with a soft cloth dampened (not wet) with water. Do not use chemicals or solvents. Vacuum the front and rear grills periodically to remove any lint buildup.

### CLEANING THE PCO CELL:

Remove the PCO cell and carefully vacuum accumulated lint. Do not wash the PCO cell. Damage from water may result.

### REAR LINT SCREEN CLEANING:

You have two options to clean the rear lint screen:

1. When visibly dirty, simply remove the rear lint screen from the unit (see pages 8-9), and with a hand-held vacuum, remove the heavy particulate. This method will extend the life of the lint screen.
2. When visibly dirty, remove the lint screen from the unit (see pages 8-9) carefully vacuum, then wash in hot water (do not use soap). Allow to dry prior to reinstalling. Replace if damaged

### REAR LINT SCREEN REPLACEMENT:

See pages 8-9 for removal and installation instructions

CAUTION: Unplug the unit before performing any maintenance procedures



## GENERAL MAINTENANCE (cont).

### CLEANING THE PURIFIER PLATE:

Remove the rear lint screen (see pages 8-9). Carefully remove the purifier plate from the card cage by grasping the middle of the edge nearest to you, and slowly pull it straight out.

If you are in an environment where there are fats, oils, or grease, such as in a kitchen, start by cleaning with denatured alcohol and a soft bristle brush. This will cut the grease without leaving a residue.

For all applications - Clean with a mixture of one part water and one part ammonia to remove contaminants.

Place the plate into a shallow dish, and pour enough of the water/ammonia solution into the dish to just cover the plate. Allow the plate to soak for no more than 10 minutes.

**CAUTION:** Damage may result from soaking the purifier plate longer than 10 minutes.

Remove the plate and scrub with a soft bristle brush. Rinse thoroughly. Let air-dry for 24 hours or use a blow dryer to dry thoroughly.

The unit will display a REPLACE PLATE message if the purification plate needs to be replaced.

### CHANGING THE PCO CELL:

The PCO Cell should be changed when REPLACE PCO CELL appears on the display, or every two (2) years, whichever comes first. To change the PCO cell, follow the instructions on page 8-9.

## OPTIONAL PREFILTER

#### To Remove:

- Rear Back Panel
- Follow steps 1-3, pg 8
- Prefilter
- Follow steps 4-5, pg 8

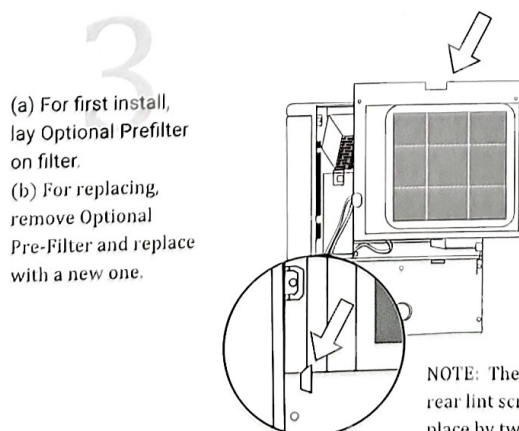
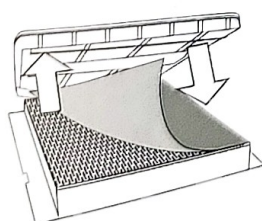
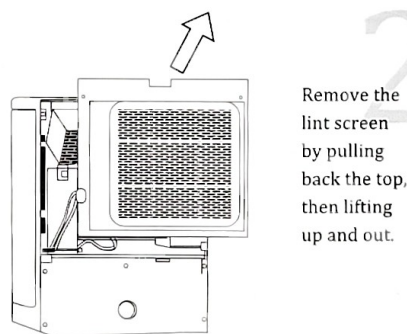
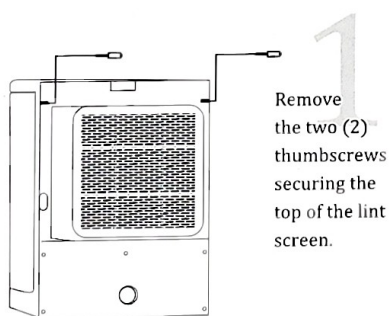

**NOTE:** The bottom of the rear lint screen is held into place by two alignment guides (see inset).

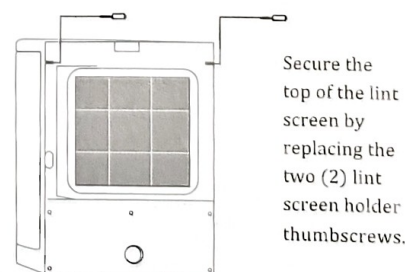

## REMOVING THE REAR LINT SCREEN

**To Remove:**

- RearLint Screen
- Follow steps 1-5
- Purifier Plate
- Follow steps 1-6
- PCO Cell
- Follow steps 1-10

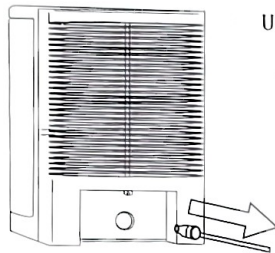

1  
Unplug Unit.

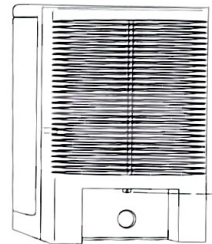

2  
Remove the back cover screw.

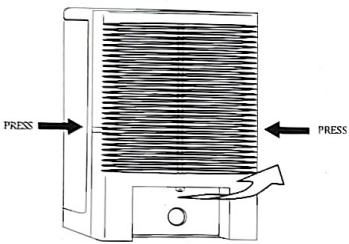

3  
Remove the back cover. Press the sides to unlatch, then tilt the bottom out to remove.

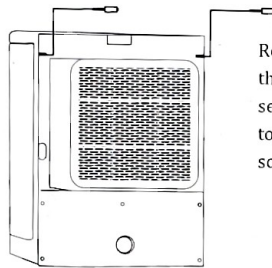

4  
Remove two thumbscrews securing the top of the lint screen.

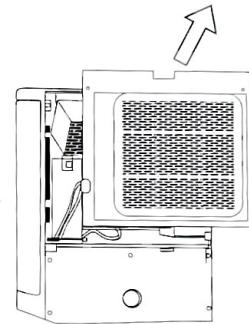

5  
Remove the lint screen by pulling back the top, then lifting up and out.

## REMOVING THE PURIFIER PLATE & PCO CELL

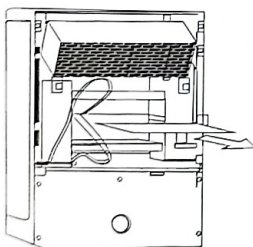

1  
To remove the purification plate, grasp the edge of the plate in the center and gently pull out.

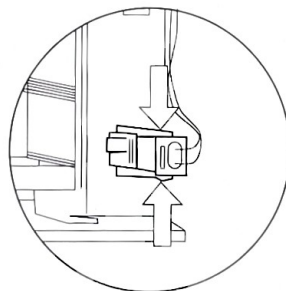

2  
Unlock the PCO cell connector by pressing on the connector's locking tabs.

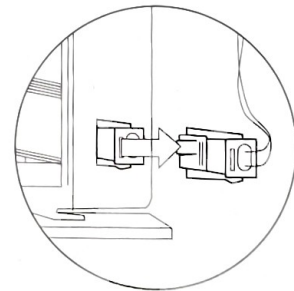

3  
Pull the connector straight out to unplug.

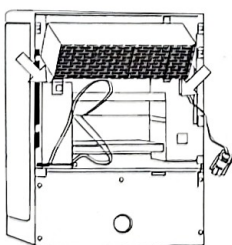

4  
Remove two (2) thumbscrews.

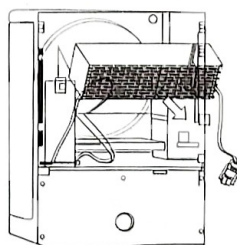

5  
Slide the PCO cell down and out of unit.

**WARNING:** Do not operate FreshAir by LT&B without the rear lint screen and back cover properly installed.



## INSTALLING THE PCO & PURIFIER PLATE

**To Install:**

- Rear Lint Screen  
Follow steps 5-9
- Purifier Plate  
Follow steps 4-9
- PCO Cell  
Follow steps 1-9

When installing the purification plate, be sure the metal tabs are making contact with the screen on each side of plate.

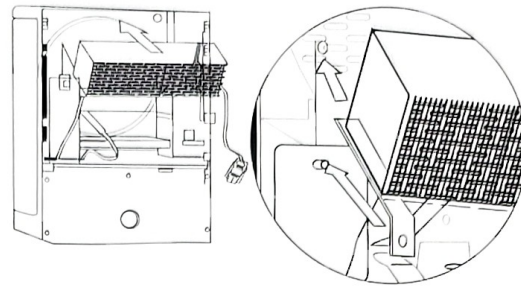

**1**  
Slide the PCO cell up into the unit. Be sure the back lip of the PCO cell engages the two slotted protrusions at the rear of the plate cage, and that the angle brackets and studs are correctly aligned.

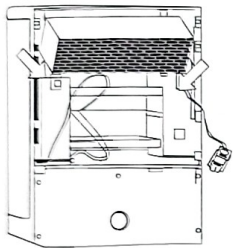

**2**  
Replace the two (2) thumbscrews and tighten.

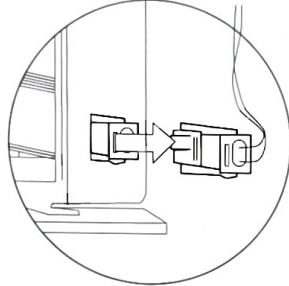

**3**  
Insert the PCO cell connector into the plug on the plate cage. Press the connector firmly until the two tabs lock into place.

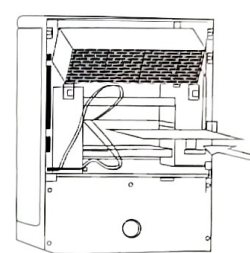

**4**  
Gently insert the purifier plate between the guides (inside the cage) until it stops.

## INSTALLING THE REAR LINT SCREEN

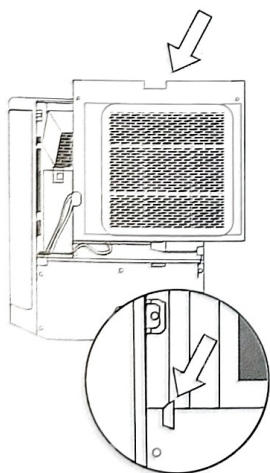

**5**  
Replace the rear lint screen, inserting the bottom of the lint screen first.

**NOTE:** The bottom of the rear lint screen is held into place by two alignment guides (see insert).

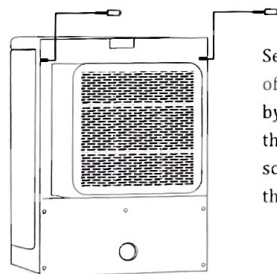

**6**  
Secure the top of the lint screen by replacing the two (2) lint screen holder thumbscrews.

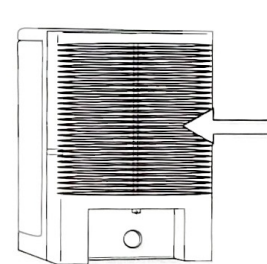

**7**  
Replace the back cover by snapping into place.

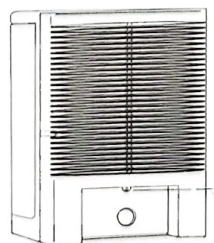

**8**  
Replace the back cover screw.

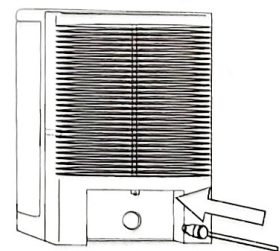

**9**  
Reinstall the power cord.

**WARNING:** Do not operate FreshAir by LT&B without the rear lint screen and back cover properly installed.

## TROUBLESHOOTING

---

### INDICATORS OF OPERATION:

When the unit is on, the LCD display will show either the fan setting and NORMAL, or the fan setting, purifier setting and square footage. If the unit is in Away Mode, it will display AWAY MODE plus the hours and minutes remaining. See page 4 for more information.

### TROUBLESHOOTING - WHAT TO LOOK FOR FIRST:

1. I have plugged in the unit, pressed the ON button on the remote (or the unit), and nothing happens... what's wrong?

- Make sure the power cord is inserted completely into the receptacle on the back of the unit;
  - Make sure the electrical outlet is capable of providing power to the unit and its contact with the unit is proper;
  - Check to see if the proper fuse is installed and that it is operational.
- 

If you are operating your central heating and air conditioning fan, or other ventilation system continuously, set the coverage up to the total ventilated indoor area. Otherwise, set the coverage up to the size of the room. Do not exceed the size of the ventilated indoor area when setting the purifier level.

---

\*Please note: The AWAY MODE should be operated in unoccupied areas only. "Unoccupied areas" include pets. Some pets, like humans, may experience adverse reactions from exposure to increased levels of O<sub>3</sub> and should not be present during AWAY MODE operation.

---

2. The fan is operating but the purifier plate is not working... what's wrong?

- The unit is in Normal Mode (press the Normal/High switch to change to High Mode).
- If the unit is displaying a REPLACE PLATE message, check the purifier plate for serviceability.
- If it is cracked or broken the purifier plate will require replacement.
- Ensure maintenance procedures required for the purified plate have been performed according to the "Maintenance" section of this Owner's Manual. Order new purifier plates from your LT&B Business Owner.

- The electrical stainless steel contacts are not contacting the screen portion of the purifier plate. Unplug and inspect the unit for any loose connections.
  - Do not attempt to disassemble the unit. This will avoid the warranty of the product.
3. The purifier plate is making a noise, has a burning smell, and/or appears to arc or spark. What is the problem?
- The purifier plate is mostly cracked. The unit will display a REPLATE PLATE message. Refer to the answers for question #2, as it would apply to this question also.
4. The UV lamp is not functioning/I'm getting a "Replace PCO cell" message
- Check PCO cell for proper installation
  - Replace the PCO cell
- 

CAUTION: Do not look directly at the glowing lamp. Prolonged exposure, even to reflected UV light, can cause eye damage according to the American Conference of Governmental Industrial Hygienists (ACGIH) Standards. FreshAir by LT&B emits UV light which can cause eye damage if the light were looked at continuously, for 20 minutes or more, at a distance of one (1) inch or less.

---

5. What are the most typical application problems?
- **SYMPTOMS:** A belief that the proper equipment is placed in the environment and the equipment appears unsuccessful.  
**PROBLEM:** Lack of air movement, improper placement of the unit.
  - **SYMPTOM:** Strong odours still remain within the environment after placement.  
**PROBLEM:** Purifier setting is too low, improper placement of the unit, or the source of the odour has not been eliminated.
  - **SYMPTOM:** A strong odor of O<sub>3</sub> is present within the environment.  
**PROBLEM:** Too much O<sub>3</sub> accumulation within the environment, as a result of improper purifier control setting, and/or lack of air movement.
  - **SYMPTOM:** Visual haze of smoke and/or particulates remain within the environment.



## TROUBLESHOOTING (cont).

---

6. Air flow is restricted or reduced

- Is the unit properly placed away from objects that may obstruct air flow?
- Are the rear lint screen, back cover and front grill clean?
- Is the PCO cell clean?

7. How can I tell if the PCO cell is functioning?

- The PCO cell will produce a glow that is visible through the front grill under low light conditions.

8. Unit does not operate

- Is the unit plugged in?
- Are you sure the outlet is active?
- Are the rear lint screen and back cover installed properly?
- Does the fuse need to be replaced?