



# Declaration of Conformity

In accordance with  
European Directive 89/336/EEC as Amended by European Directive 93/68/EEC  
"EMC Directive"  
European Directive 73/23/EEC as amended by European Directive 93/68/EEC  
"Low Voltage Directive"

**Date:** 10<sup>th</sup> August 2004

**Manufacturer:** Environmental Health Services  
310 T.Elmer Cox Drive  
Greenville  
Tennessee  
TN 37744  
USA

**Authorized Representative:** Epsilon Certification Service  
Drury Lane  
Drury  
Buckley  
Flinshire  
CH7 3DU

**ECS Project Number:** ETS1068

**On behalf of the manufacturer, Epsilon hereby declares that the Electronic Air Purification System:**  
  
Fresh Air

To which this declaration relates are declared as being in compliance with the requirements of EU Directive 89/336/EEC and 73/23/EEC. The equipment shall be designed and constructed in accordance with the specification set out in the Technical file held by Epsilon Certification Service and documents referred to therein.

**Equipment Specification:** The full product specifications are listed in reports issued by Philips Testing Services TDR-039-2003.33001/RM and Entela 0312018505

**The following Harmonised European Standards have been applied:**

**IEC/EN 60335-: 1991 + A1: 94 + A2: 99** Specification for safety of household and similar electrical appliances. General requirements.  
**IEC/EN 60335-2-65: 1993 + A1: 2000** Specification for safety of household and similar electrical appliances. Particular requirements. Air-cleaning appliances.  
**EN 55014-1: 2001** Electromagnetic compatibility. Requirements for household appliances, electric tools and similar apparatus. Emission.  
**EN 50014-2: 1997** Electromagnetic compatibility. Requirements for household appliances, electric tools and similar apparatus. Immunity.

**This Declaration May Only Be Used In Its Entirety and Without Change**

On Behalf of Environmental Health Services.

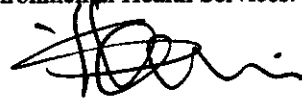

  
Stephen L D'Henin  
Certification Manager  
Epsilon Certification Service



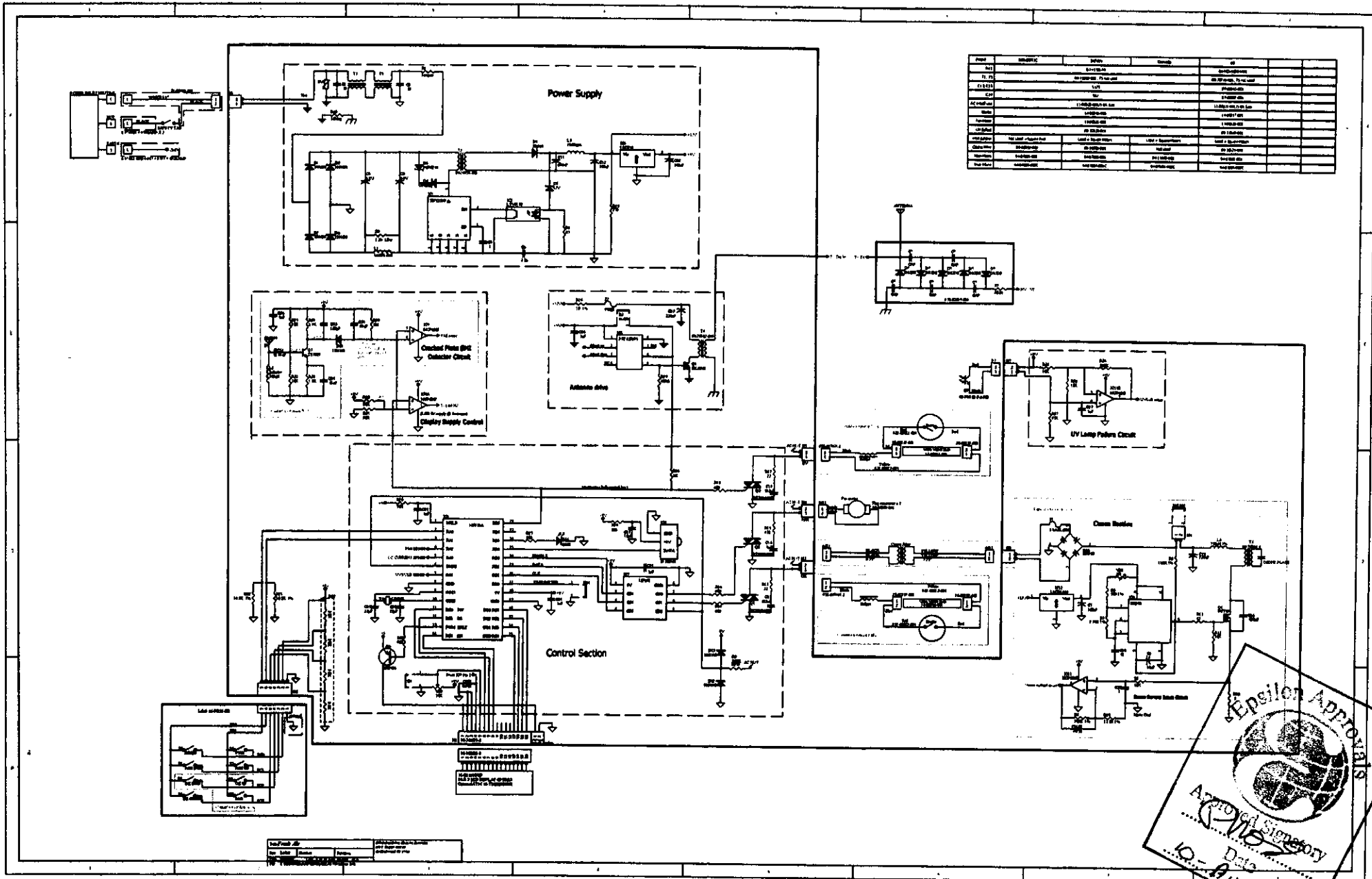

Part	Quantity	Part	Quantity	Part	Quantity
100	1	100	1	100	1
101	1	101	1	101	1
102	1	102	1	102	1
103	1	103	1	103	1
104	1	104	1	104	1
105	1	105	1	105	1
106	1	106	1	106	1
107	1	107	1	107	1
108	1	108	1	108	1
109	1	109	1	109	1
110	1	110	1	110	1
111	1	111	1	111	1
112	1	112	1	112	1
113	1	113	1	113	1
114	1	114	1	114	1
115	1	115	1	115	1
116	1	116	1	116	1
117	1	117	1	117	1
118	1	118	1	118	1
119	1	119	1	119	1
120	1	120	1	120	1

Epsilon Approval

Approval Signatory  
Date: 10-10-2010  
10-10-2010

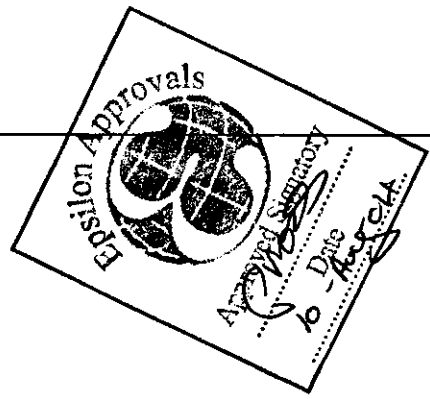

21-30327-004

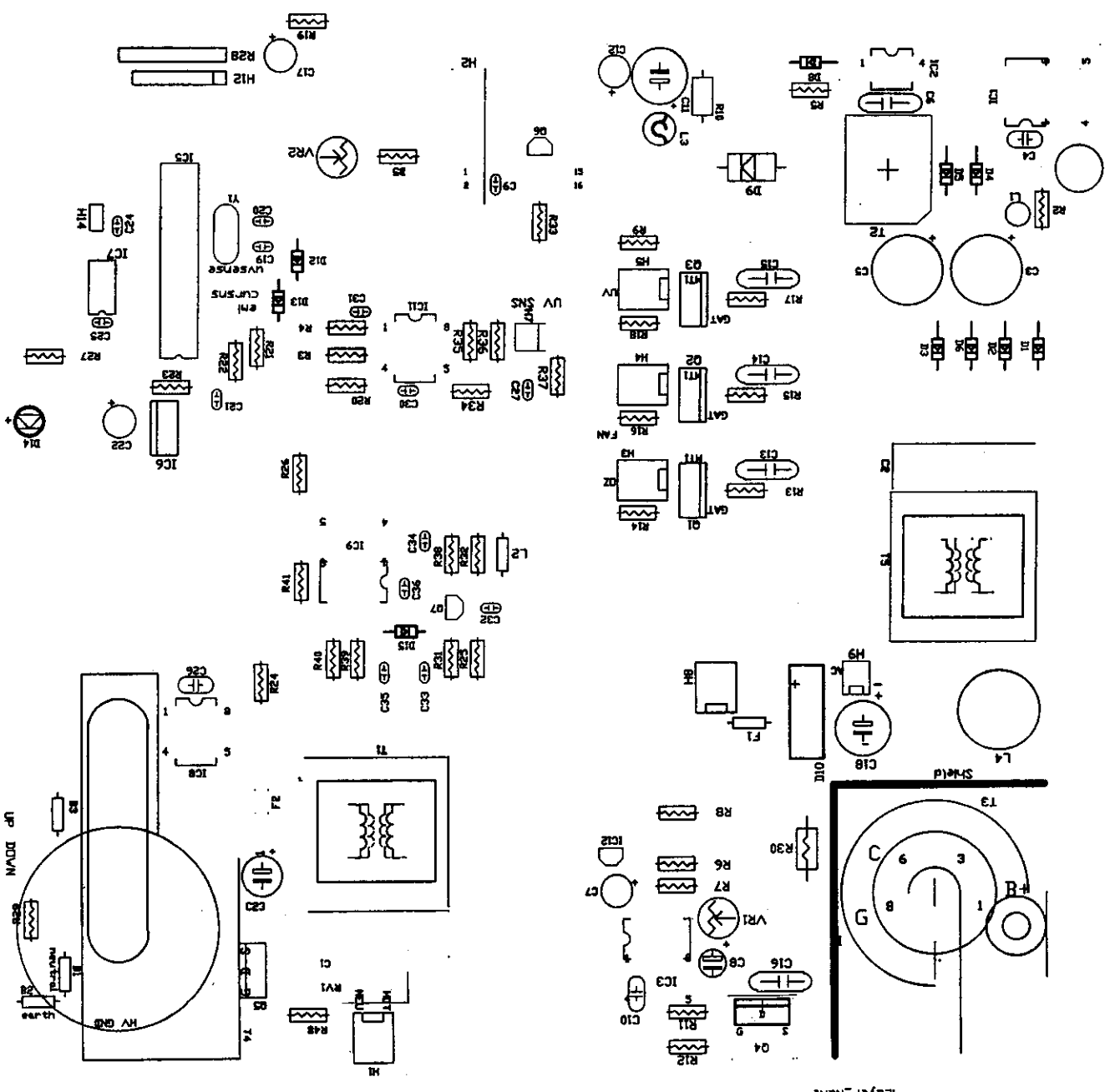

MODEL:

PART NO:

WELL NO: WT-92005

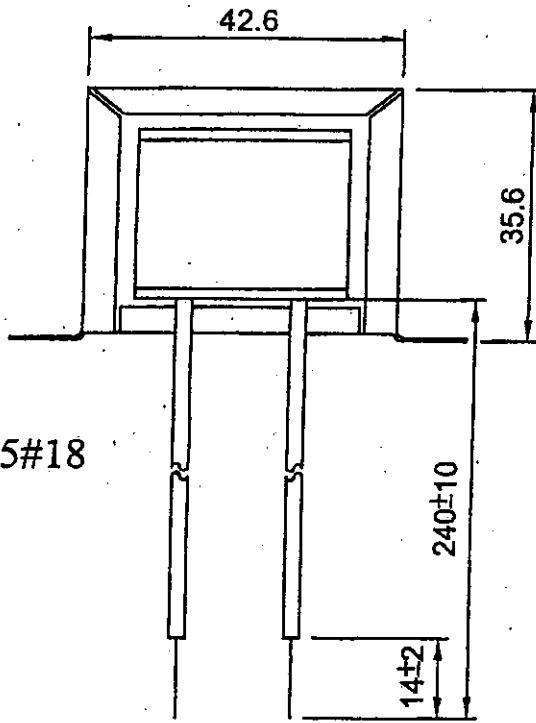
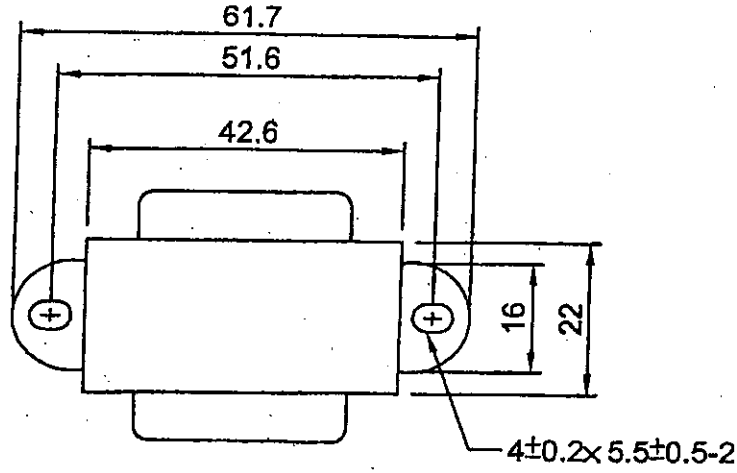
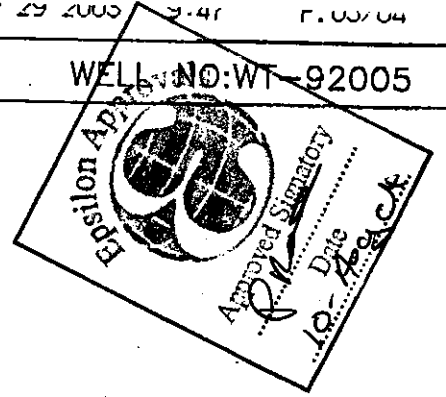

UL1015#18

BLK WHT



WELL ELECTRONICS CO., LTD.

TITL: TRANSFORMER

DWG: WT-92005

UNIT mm

CHKD/APPRVD: [Signature] 8/15

DATE: AUG. 15, 2003

DWG BY: JENNY

PAGE OF A4

MODEL:

PART NO:

WELL NO: WT-92005

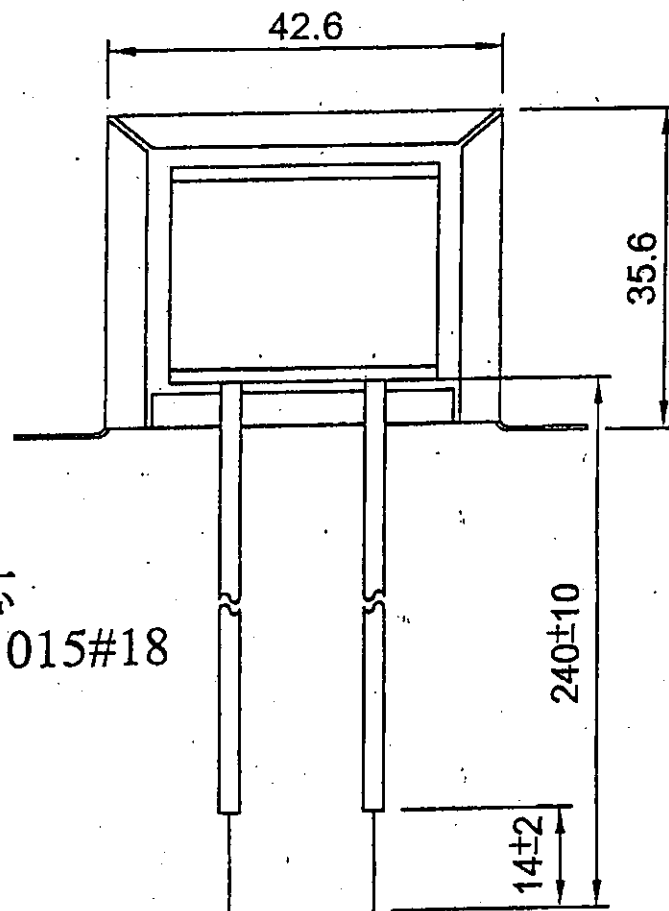
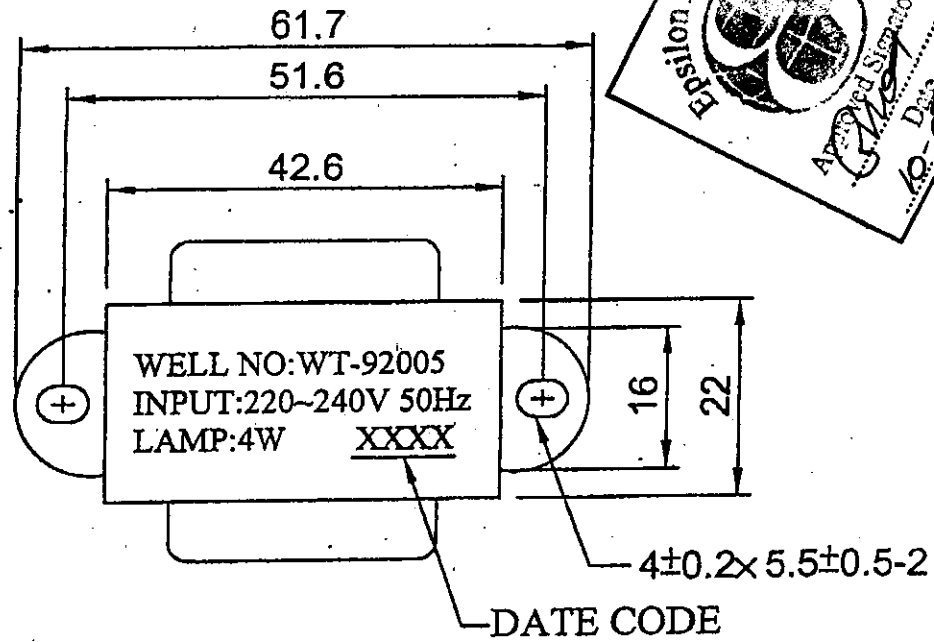
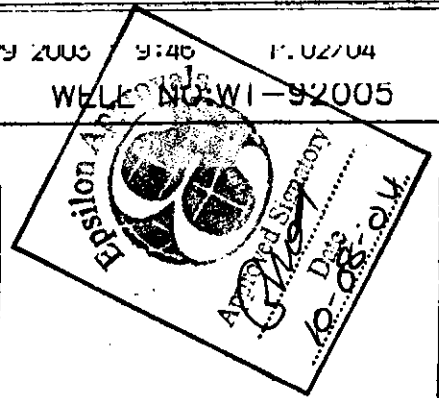

單芯  
UL1015#18

BLK WHT

TOLERANCE: ±1



WELL ELECTRONICS CO., LTD.

TITLE: TRANSFORMER

DWG: WT-92005

UNIT  
mm

CHECKD/APPRVD: *Jenny* 10/29

DATE: OCT. 29, 2003

DWG BY: JENNY

PAGE OF A4

To: DALE COLEMAN #09-31010-001

PK-1

# WELL WELL ELECTRONICS CO., LTD

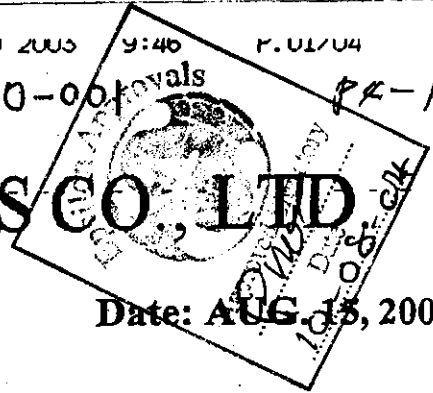

Model: Part No: Well No: WT-92005 Date: AUG 15, 2003

1. Product Name : Ballast
2. Input Rated Voltage: 220~240 V AC 50 Hz.
3. Operation Current : 150±20 mA.
4. Lamp Voltage: 30 V AC.
5. Hi-Pot Test : 1200V 50/60Hz For One Minute Between Winding To Core;
6. Insulation Test : DC 500V 100M OHM MIN . Between Winding To Core .
7. Schematic Diagram :

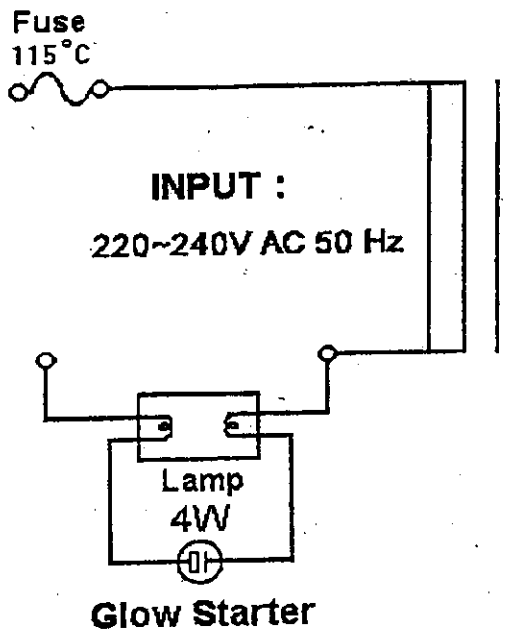

DSIGNED : *[Signature]*

CHECKED :



SINGLE-LEVEL BILL OF MATERIALS REPORT

Environmental Health Service

WITH PHANTOM BLOW THROU

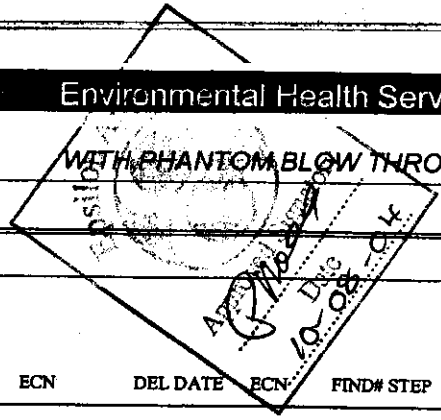

BILL #	REVISION	OPTN	TYPE	U/M	DESCRIPTION						
401-220G	000 (CURRENT)	BASE	STANDARD	EACH	Fresh Air 220 Graphite w/						
LAST USED:		YIELD%:		100.000%	MAX LOT SIZE:		0				
COMPONENT	REV	TYP	QTY/BILL	U/M	SCRAP %	DESCRIPTION	ADD DATE	ECN	DEL DATE	ECN	FIND# STEP
01-2N3906			1.00	EACH	0.000%	IC TRANS PNP SS GP 200MA TO-92					
01-390261-2			2.00	EACH	0.000%	IC SOCKET 8 PIN AMP # 390261-2					
01-390261-9			1.00	EACH	0.000%	IC SOCKET 28 PIN AMP #390261-9					
01-7805CV			1.00	EACH	0.000%	IC SGS # 7805CV					
01-LM78L09ACZ			1.00	EACH	0.000%	IC National Semi # LM78L09ACZ					
01-LTV817D-LIT			1.00	EACH	0.000%	IC CHIP, OPTOCOUPLER - LITEON					
01-MCP6022			2.00	EACH	0.000%	IC MICROCHIP # MCP6022-1/P					
01-TSOP1238			1.00	EACH	0.000%	IR RECEIVER STRAIGHT LEADS VIS					
01-TNY255P-TS			1.00	EACH	0.000%	IC CHIP TINY SWITCH TNY255P					
02-00003-001			1.00	EACH	0.000%	TRANSISTOR IRL630					
02-RPT-37PB3F			1.00	EACH	0.000%	TRANSISTOR PHOTO -ROHM-RPT-37					
04-00004-001			4.00	EACH	0.000%	DIODE 1N4007-Cchange on everyt					
04-1N5242B			1.00	EACH	0.000%	DIODE ZENER 12V DIGIKEY # 1N52					
04-P6KE200			1.00	EACH	0.000%	DIODE P6KE200 Micro Commercial					
04-SB360-P			1.00	EACH	0.000%	DIODE, SCHOTTKY SB360 FORMED					
04-UF4007-GI			1.00	EACH	0.000%	DIODE UF4007 GSI/Vishay					
05-10K00-211			1.00	EACH	0.000%	RESISTOR 10 OHM 1/4W 1%					
05-1K000-223			1.00	EACH	0.000%	RESISTOR 1K ohm 1/4 w 5%					
05-1K200-323			1.00	EACH	0.000%	RESISTOR 1.2K OHM 1/2W 5%					
05-1K300-223			1.00	EACH	0.000%	RESISTOR 1.3 K OHM 1/4W					
05-1M000-223			1.00	EACH	0.000%	RESISTOR 1M ohm 1/4W / SAME A					
05-10K20-211			2.00	EACH	0.000%	RESISTOR 10.2K OHM 1/4W 1%					
05-10M00-223			1.00	EACH	0.000%	RESISTOR 10meg ohm 1/4w					
05-110K0-211			1.00	EACH	0.000%	RESISTOR 110K ohm 1/4W 1%					
05-13K30-211			1.00	EACH	0.000%	RESISTOR 1% METAL FILM 1/4 WAT					
05-16K00-223			1.00	EACH	0.000%	RESISTOR 16k ohm 1/4w					
05-270R0-323			1.00	EACH	0.000%	RESISTOR 270 OHM 1/2W 5% CF					
05-2K740-211			1.00	EACH	0.000%	RESISTOR 2.74K 1/4w 1%					
05-30K00-223			1.00	EACH	0.000%	RESISTOR 30K ohm 1/4W					
05-300K0-223			1.00	EACH	0.000%	RESISTOR 300K OHM 1/4W					
05-300K0-323			1.00	EACH	0.000%	RESISTOR 300K OHM 1/2W					
05-300R0-223			2.00	EACH	0.000%	RESISTOR 300 OHM 1/4W					
05-392K0-211			1.00	EACH	0.000%	RESISTOR 392k 1/4w 1% METAL FI					
05-3K300-B62			1.00	EACH	0.000%	RESISTOR NET 8 SIP ISOLATED 3.					
05-47K00-223			1.00	EACH	0.000%	RESISTOR 47k ohm 1/4w					



SINGLE-LEVEL BILL OF MATERIALS REPORT

Environmental Health Service

WITH PHANTOM BLOW THROU

BILL	REVISION	OPTN	TYPE	U/M	DESCRIPTION	ADD DATE	ECN	DEL DATE	ECN	FIND#	STEP
401...220G	000 (CURRENT)	BASE	STANDARD	EACH	Fresh Air 220 Graphite w/						
COMPONENT	REV	TYP	QTY/BILL	U/M	DESCRIPTION	ADD DATE	ECN	DEL DATE	ECN	FIND#	STEP
05-820R0-223			1.00	EACH	0.000% RESISTOR 820 OHM 1/4W						
05-909R0-211			1.00	EACH	0.000% RESISTOR 909 ohm 1/4 W 1%						
05-R3000-411			1.00	EACH	0.000% RESISTOR 0.300ohm 1% 1 W RFE#						
06-MOV10MM-RFE			1.00	EACH	0.000% MOV RFE# JVR10S391K87V50						
07-00002-002			2.00	EACH	0.000% Capacitor 0.33UF 250/275VAC EM						
07-00007-001			1.00	EACH	0.000% Capacitor .1uF, 400V (C4)						
07-00010-001			2.00	EACH	0.000% Capacitor .022uf 400v METAL PO						
07-00010-005			1.00	EACH	0.000% Capacitor .022UF 630V MPP						
07-10450V-MIR-P			1.00	EACH	0.000% Capacitor 0.1UF 50V Prepped 5/						
07-10680-144			2.00	EACH	0.000% Capacitor 6.8UF 400V LYTIC						
07-11012-121			3.00	EACH	0.000% Capacitor 100uf 16v Lytic						
07-12212-132			1.00	EACH	0.000% Capacitor 220uf, 16v lytic .49						
07-12215-143			1.00	EACH	0.000% Capacitor 220UF 50V NRSA221/50						
07-22050V-MIR-P			2.00	EACH	0.000% Capacitor 22PF 50V Prepped 5/						
07-61042-112-P			9.00	EACH	0.000% Capacitor .1UF 50V PREPPED 5/8						
07-66812-234			1.00	EACH	0.000% Capacitor 680UF 16V LYTIC (LOW						
07-7722-250			1.00	EACH	0.000% Capacitor 2200PF 250V CERAMIC						
07-RD16CG101J-P			1.00	EACH	0.000% Capacitor 100 pf 5% Prepped 5/						
07-SEM100V103J			4.00	EACH	0.000% Capacitor .01UF 100V 5% SURGE						
08-001MH-JWM			1.00	EACH	0.000% INDUCTOR 1.0mH, 6 OHM BEAD AXI						
08-100UH-JWM			1.00	EACH	0.000% INDUCTOR 100UH JW MILLER 78F10						
08-20213-001			1.00	EACH	0.000% INDUCTOR 750 UH MFG. RENCO # R						
08-28CO236-OEW			1.00	EACH	0.000% EMI CHOKE, 28CO236-OEW STEWARD						
09-0716-001			1.00	EACH	0.000% LINE CHOKE 33mh X 2 .5a RENC						
09-20924-001			1.00	EACH	0.000% TRANSFORMER SWITCHMODE T&L #						
09-31010-001			1.00	EACH	0.000% Balast transformer 220-240V 50						
09-70512-004			1.00	EACH	0.000% TRANSFORMER FLYBACK						
09-70724-003			1.00	EACH	0.000% FLYBACK TRANSFORMER GSG#F-185						
09-30523-001			1.00	EACH	0.000% Transformer 240/285 50/60 Hz P						
10-00002-001			4.00	EA	0.000% CONN. .250 22-18 FEMALE 2-5201						
10-00002-001L			1.00	EA	0.000% CONN. .250 22-18 FEMALE 2-5201						
10-00009-001			2.00	EACH	0.000% CONN. FLAG AMP 3-520132-2 T&R						
10-00011-001			3.00	EACH	0.000% CONN. TERM FEMALE AMP#2-520181						
10-103321-7			1.00	EACH	0.000% Header 7 pin single row						
10-103328-8			1.00	EACH	0.000% HEADER AMP #103328-8						
10-			3.00	EACH	0.000% TRIAC SGS BTB06-600T						

SINGLE-LEVEL BILL OF MATERIALS REPORT

Environmental Health Service

WITH PHANTOM BLOW THROU

BIL#	REVISION	OPTN	TYPE	U/M	DESCRIPTION	ADD DATE	ECN	DEL DATE	ECN	FIND# STEP	
401	000 (CURRENT)	BASE	STANDARD	EACH	Fresh Air 220 Graphite w/						
COMPONENT	REV	TYP	QTY/BILL	U/M	SCRAP %	DESCRIPTION	ADD DATE	ECN	DEL DATE	ECN	FIND# STEP
10-647401-2			1.00	EACH	0.000%	CONNECTOR 2 pin White Amp # 64					
10-770476-1			2.00	EACH	0.000%	Pin for Connector Amp #770476-					
11-00021-001			1.00	EACH	0.000%	SWITCH POWER WITH CORD ADAPTER					
11-00027-001			1.00	EACH	0.000%	Switch, Micro-switch Cchange					
13-00020-001			1.00	EACH	0.000%	DO NOT ORDER THIS. Fan Motor					
14-00013-001			1.00	EACH	0.000%	BULB GERMICIEAL					
14-00014-001			1.00	EACH	0.000%	Lens Cover, Clear Visual C					
14-00016-001			1.00	EACH	0.000%	Bulb, Glow Bulb Starter Honsa					
17-00002-001			1.00	EACH	0.000%	CRYSTAL, QUARTZ 12 MHZ MFG # E					
			1.00	EACH	0.000%	LED DIODE L934LGD GR light emi					
18-CS1505NFJ			1.00	EACH	0.000%	LCD Disply Mfg. Optrex # C-515					
19-2123232-000			1.00	EACH	0.000%	Standoff Round 6-32 X1/4X3/8 F					
21-30327-004			1.00	EACH	0.000%	PC Board Fresh Air					
22-00012-001			1.33	FEET	0.000%	WIRE 18AWG RED TINNED/TOP COAT					
22-00013-001			0.67	FEET	0.000%	WIRE 18AWG YELLOW TINNED/TOP C					
22-00024-001			2.00	FT	0.000%	WIRE 20AWG UL1015 GREEN Cchan					
22-00027-001			0.25	FEET	0.000%	HEAT SHRINK TUBING 3/32 X 1/2					
23-21104-001			1.00	EACH	0.000%	POWER CORD 8' 2" Breeze AT 220					
248			1.00	EACH	0.000%	WASHER INTERNAL TOOTH LOCK #6					
249			1.00	EACH	0.000%	NUTS MINI-HEX 6-32					
257P			2.00	EACH	0.000%	6-32X3/8 PHIL PAN HD W/STAR					
259			2.00	EACH	0.000%	NUT HEX 8-32					
26-00021-001			1.00	EACH	0.000%	GROMMET					
26-00022-001			2.00	EACH	0.000%	HEX NUT 6-32 W/LOCK W ATTACHED					
267P			2.00	EACH	0.000%	6-32X1/4 AND STAR WASHER SEMS					
27-00084-003			2.00	EACH	0.000%	SPRING 0.020 SS304					
27-00155-001			1.00	EACH	0.000%	ELECTRODE CONNECTOR (PIN)					
27-00304-001	*	STD	1.00	EACH	0.000%	ANTENNA 3 RINGS BLUNT TIPS (MA					
27-00368-001			1.00	EACH	0.000%	Bracket Cage Left Fresh Air					
27-00369-001			1.00	EACH	0.000%	Bracket Cage Right Fresh Air					
27-00370-003			1.00	EACH	0.000%	Chassis Fresh Air A change					
27-00371-002			1.00	EACH	0.000%	Shield UV Front					
27-00373-001			1.00	EACH	0.000%	Filter Spring Clip					
27-00374-004			2.00	EACH	0.000%	Fan Bracket Cchange-use 002 fi					
27-00382-001			1.00	EACH	0.000%	Bracket, Transformer support					
27-00383-001			2.00	EACH	0.000%	Bulb Holder Clip					

SINGLE-LEVEL BILL OF MATERIALS REPORT

Environmental Health Service

WITH PHANTOM BLOW THROU

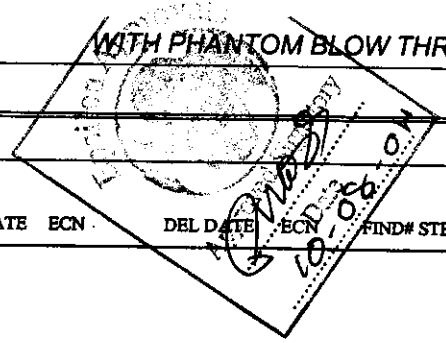

BILL	REVISION	OPTN	TYPE	U/M	DESCRIPTION	ADD DATE	ECN	DEL DATE	ECN	FIND#	STEP	
40	000 (CURRENT)	BASE	STANDARD	EACH	Fresh Air 220 Graphite w/							
COMPONENT	REV	TYP	QTY/BILL	U/M	SCRAP %	DESCRIPTION	ADD DATE	ECN	DEL DATE	ECN	FIND#	STEP
28-00062-006			2.00	EACH	0.000%	PLATE GUIDE BLK 94-VO P/P						
28-00065-006			4.00	EACH	0.000%	POST DELRIN OR POLY WHITE						
28-00192-001			1.00	EACH	0.000%	FAN BLADE 6CW 6" UL94VO						
28-00219-001			1.00	EACH	0.000%	CLIP VERTICAL CORD PANDUIT #VC						
28-00241-001			1.00	EACH	0.000%	SOCKET CONNECTOR MITRONIX # T						
28-00237-001			2.00	EACH	0.000%	Socket, T503 T5 Fluorescent S						
28-00252-001			1.00	EACH	0.000%	LCD Cover- Lexan .030						
28-00256-001			1.00	EACH	0.000%	Shield UV Rear Plastic						
30-00024-001	*	STD	1.00	EACH	0.000%	Cabinet Fresh Air Graphite						
3000			0.75	FEET	0.000%	18awg BLK HV SIL 3-0082-5 WIRE						
3001			1.96	FT	0.000%	WIRE 03-0082-5 18GA 20KV DC RE						
302			1.00	EACH	0.000%	Standoff 6-32X 1"X .5"Dia.F/F						
310			4.00	EACH	0.000%	RUBBER BUMP ON FEET BLK						
31-12113-010			12.00	EACH	0.000%	Screw 6-32 X 1/4" Swedgrform P						
31-1215D-040			4.00	EACH	0.000%	SCREW 8-18 X 3/4" PPH HI/LOW P						
31-12143-010			2.00	EACH	0.000%	Screw , 4-40 Swedgeform PPH						
31-1195-010			7.00	EACH	0.000%	SCREW 6-32 X5/16 SWAGEFORM						
337			3.00	EACH	1.000%	TERMINAL RING 2-34144-1						
338AMP			3.00	EACH	0.000%	FASTON .205 FEMALE 696018-2						
354			1.00	EACH	0.000%	HEAT SINK SMALL 576802 AAVID						
355			3.00	EACH	0.000%	GROMMET 35 TO 40 Duro 5052-160						
36-00005-003			1.00	EACH	0.000%	ION NEEDLE 1/2"						
36-00052-001			1.00	EACH	0.000%	Remote, IRSI-0715A-RS-1/0102						
36-00053-001			1.00	EACH	0.000%	SCREEN EcoTech TIO2						
360			4.00	EACH	0.000%	FASTON MALE AMP 42822-4 TABS F						
361			0.17	FT	0.000%	TAPE DOUBLE BACK FOAM 1/2" W						
38-00010-001			1.00	EACH	0.000%	XL FILTER, CARBON (NO EYELET)						
39-00009-001			2.00	EACH	0.000%	Ozone Plate, Ceramic' Complete						
404			0.71	FT	0.000%	WIRE 20AWG UL1015 BLACK						
407			1.00	FT	0.000%	WIRE 20AWG UL1015 VIOLET						
4117			1.00	EACH	0.000%	MICRO SHUNT JUN 02 SS-GOB CR						
413			6.00	EACH	0.000%	HEADER AMP 644-752-2 MALE						
4131			2.00	EA	0.000%	HEADER 2-PIN MTA .100 STRAIGHT						
4133			1.00	EA	0.000%	CONN 2-PIN 640468-2 AMP						
42-00004-001			2.00	EACH	0.000%	BATTERY AAA						
437			0.50	FT	0.000%	WIRE 22AWG UL1007 BLK						

SINGLE-LEVEL BILL OF MATERIALS REPORT

Environmental Health Servi

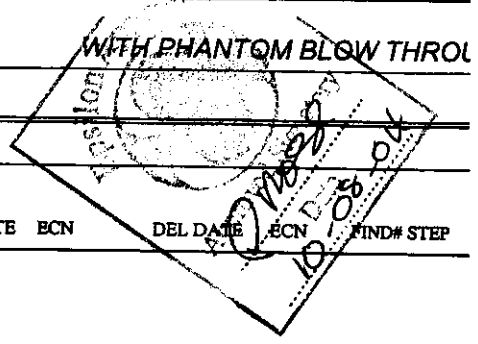

BILL	REVISION	OPTN	TYPE	U/M	DESCRIPTION	ADD DATE	ECN	DEL DATE	ECN	FIND#	STEP	
40...	000 (CURRENT)	BASE	STANDARD	EACH	Fresh Air 220 Graphite w/							
COMPONENT	REV	TYP	QTY/BILL	U/M	SCRAP %	DESCRIPTION	ADD DATE	ECN	DEL DATE	ECN	FIND#	STEP
436			0.50	FT	0.000%	WIRE 22 AWG RED 7/30 STRANDED(X						
4506			1.00	EACH	0.000%	RESISTOR 1.5k						
4510			1.00	EACH	0.000%	RESISTOR 15K 1/4W T&R						
4543			1.00	EACH	0.000%	RESISTOR 470 OHM 5% 1/4 W						
4571			1.00	EACH	0.000%	RESISTOR 20K, 1/4W						
5056			1.00	EACH	0.000%	TRIMPOT 2k 6mm dia., to adjus						
506			3.00	EACH	0.000%	DIODE IN4148 75v						
5083			1.00	EACH	0.000%	FUSE BELL MS 1.5 SLOW BLOW Or						
5104			1.00	EACH	0.000%	FUSE, 100ma SLOW BLOW LONG LE						
5114P			1.00	EA	0.000%	BRIDGE RECTIFIER 100V 2A BR81D						
			2.00	EA	0.000%	Capacitor 10uf 35V LYTIC						
5170			1.00	EA	0.000%	TMOSS IRF740 400V/10A						
5171			1.00	EACH	0.000%	TRANSISTOR RF NPNZTX325						
547			2.00	EACH	0.000%	RESISTOR 22 OHM 1/4W						
548			3.00	EACH	0.000%	RESISTOR 680 OHM 1/4 W						
552			1.00	EACH	0.000%	IC CHIP NE555P						
57			2.00	EACH	0.000%	RESISTOR 47 OHM 1/4 W						
575			6.00	EACH	0.000%	RESISTOR 10K OHM 1/4W						
5802			10.00	EACH	0.000%	SCREW 6-20 X 1/2" PPH PLASTI-F						
587			4.00	EACH	0.000%	RESISTOR 0 OHM 1/4W T&R						
61-00054-001			1.00	EACH	0.000%	CARTON FRESH AIR						
61-00057-001			2.00	EACH	0.000%	Bag Zip Lock 6" X 10"						
61-917F			2.00	EA	0.000%	FOAM POUCH FOR OZONE PLATE						
62-00018-001			1.00	EACH	0.000%	LABEL, DO NOT DEFEAT						
62-00020-001			1.00	EACH	0.000%	CAUTION, HIGH VOLTAGE (RED)						
62-00224-001			1.00	EACH	0.000%	LABEL, KEYPAD OVERLAY-Black w/						
62-00234-001			1.00	EACH	0.000%	Label, Combination Serial and						
6201			1.00	EACH	0.000%	FOR OWNERS MANUAL CALL 1-800						
65-00006-002			1.00	EACH	0.000%	Warranty Card 120V ECOQUEST						
65-00087-002			1.00	EACH	0.000%	Owners Manual Fresh Air 100v/1						
65-00090-001			1.00	EACH	0.000%	Quickstart Instruction Fresh A						
70-00059-002	*	STD	1.00	EACH	0.000%	TRIPLER BLOCK, FRESH AIR						
72-00004-003	*	STD	1.00	EACH	0.000%	WIRE ASSY' Switch to Board						
72-00016-001	*	STD	1.00	EACH	0.000%	Wire Assy' Fan Fresh Air,E2500						
72-00017-001			1.00	EACH	0.000%	CABLE ASSY. FRESH AIR						
90			1.00	EACH	0.000%	POLY BAG 150&XL 12X8X24						

SINGLE-LEVEL BILL OF MATERIALS REPORT

Environmental Health Service

WITH PHANTOM BLOW THROU

BILL	REVISION	OPTN	TYPE	U/M	DESCRIPTION	ADD DATE	ECN	DEL DATE	ECN	FIND#	STEP	
401...220G	000 (CURRENT)	BASE	STANDARD	EACH	Fresh Air 220 Graphite w/							
COMPONENT	REV	TYP	QTY/BILL	U/M	SCRAP %	DESCRIPTION	ADD DATE	ECN	DEL DATE	ECN	FIND#	STEP
94-07004-001	*	STD	1.00	EACH	0.000%	Program PIC12F675-I/P Fresh Ai						
94-07005-001	*	STD	1.00	EACH	0.000%	Program For PIC16F876A-I/SP						
94-10004-001C	*	STD	1.00	EACH	0.000%	Program PIC12F675-I/P Control						
WP-170			1.00	EACH	0.000%	32837-1 #10 RING TOUNGE TERMI						

