

SAFE HEARTH®



PORTABLE HEATING SYSTEM
WITH ACTIVEPURE TECHNOLOGY

- Installation
- Operation
- Specifications
- Warranty

USER'S MANUAL

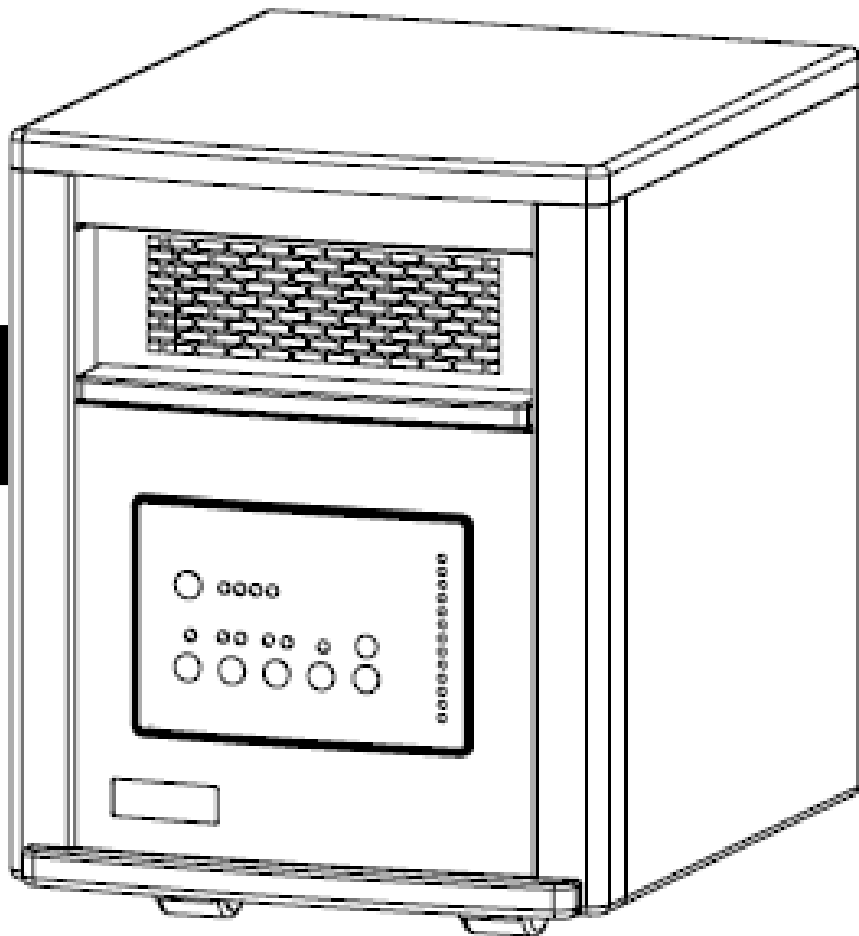
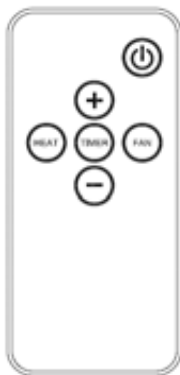

IMPORTANT INSTRUCTIONS



WARNING! - WHEN USING ELECTRICAL APPLIANCES, BASIC PRECAUTIONS SHOULD ALWAYS BE FOLLOWED TO REDUCE RISK OF FIRE, ELECTRIC SHOCK, AND INJURY TO PERSONS, INCLUDING THE FOLLOWING:

- CAUTION: Risk of Electric Shock. DO NOT open or try to repair the heater yourself.
- This heater may get hot when in use. To avoid burns, DO NOT let bare skin touch hot surfaces. Use caution when moving this heater.
- Keep combustible materials, such as furniture, pillows, bedding, paper, clothes, and curtains at least 3 ft from the front of the heater and keep them away from the sides, top, and rear. DO NOT place towels or other objects on the heater.
- Extreme caution is necessary when any heater is used by or near children or the disabled, or when the heater is left operating and unattended.
- DO NOT operate any heater with a damaged cord or after the heater malfunctions, has been dropped or damaged in any manner. Return heater to authorized service facility for examination, electrical or mechanical adjustment, or repair.
- This heater is not intended for use in bathrooms, laundry areas and similar indoor locations. NEVER locate heater where it may fall into a bathtub or other water container. To protect against electrical hazards, DO NOT immerse in water or other liquids.
- DO NOT touch the control panel or plug with a wet hand.
- DO NOT run cord under carpeting. DO NOT cover cord with throw rugs, runners, or similar coverings. Arrange cord away from traffic area and where it will not be tripped over.
- DO NOT insert or allow foreign objects to enter any ventilation or exhaust opening as this may cause an electric shock or fire, or damage the heater.
- To prevent a possible fire, DO NOT block the air intakes or exhaust in any manner. DO NOT use on soft surfaces, like a bed, where openings may become blocked.
- The heater has hot parts inside. Do not use it in areas where gasoline, paint, or flammable liquids are used or stored.
- Always plug heaters directly into a wall outlet/receptacle. Never use with an extension cord or relocatable power tap (outlet/power strip).
- Never operate heater without filter in place
- To avoid fire or shock hazard, plug the unit directly into a 120 V AC electrical outlet.
- To disconnect heater, turn controls to OFF, then remove plug from outlet. Pull firmly on the plug, DO NOT unplug by pulling on the cord.
- Always unplug the unit before moving or cleaning, or whenever the heater is not in use.
- Use only for intended household use as described in this manual. Any other use not recommended by the manufacturer may cause fire, electric shock, or injury to persons. The use of attachments not recommended or sold by unauthorized dealers may cause hazards.
- Use only on a floor that is a dry, level surface.
- DO NOT use outdoors or on wet surfaces.
- DO NOT attempt to repair or adjust any electrical or mechanical functions on this unit. Doing so will void your warranty. The inside of the unit contains no user serviceable parts. Qualified personnel should perform all servicing only.
- Connect to properly grounded outlets only.
- Check your heater cord and plug connections.
 - a) Faulty wall outlet connections or loose plugs can cause the outlet or plug to overheat. Be sure the plug fits tight in outlet.
 - b) Heaters draw more current than small appliances. Overheating of the outlet may occur even if it has not occurred with the use of other appliances.
 - c) During use, check frequently to determine if your plug outlet or faceplate is HOT!
 - d) If so, discontinue use of the heater and have a qualified electrician check and/or replace faulty outlet(s).
- To reduce the risk of electrical shock, this appliance has a grounded plug (with a third prong). This plug will fit in a grounded outlet only one way. If it does not fit, contact a qualified electrician to install the proper outlet. Do not change the plug in any way. Do not use adaptors.

SAVE THESE INSTRUCTIONS

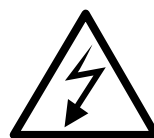

**CAUTION
RISK OF ELECTRIC SHOCK
DO NOT OPEN
NO USER-SERVICEABLE PARTS INSIDE**



WARNING! - EYE DAMAGE MAY RESULT FROM DIRECTLY VIEWING THE LIGHT PRODUCED BY THE LAMP USED IN THIS PRODUCT. ALWAYS TURN OFF & UNPLUG UNIT BEFORE OPENING THIS COVER.

INTRODUCTION

Congratulations, your new SafeHearth™ is designed to provide years of trouble-free, low maintenance operation. Be sure to read and follow all service procedures outlined in this owner's manual, and use only genuine Vollara replacement parts available from your Vollara Distributor.

If you have any questions concerning this, or any Vollara product, contact your Vollara Distributor.

Please record the name and phone number of your Vollara Distributor:

Name _____

Phone _____

Please record the serial number of your SafeHearth™:

Serial # _____

CAUTION: Do not power off the heater using the main power switch or unplugging it, except in an emergency. A cool down period prevents damage to the heater before turning off the fan. By turning off the heater using the main power switch or unplugging it from the power source, it does not cool down properly.

* Variables such as your insulation, type and number of windows, number of stories, construction type, etc. will greatly affect the required Btu's per square for heating

SPECIFICATIONS

Electrical:

- Voltage: 120V~ 60Hz
- Power consumption: 1000–1500 Watts.
- Heat output: rated at 5,100 BTU
- Automatic shut-off: heat can be set to automatically shut off. 2,4,6 or 8 hours
- Expected lifecycle: over 28000 hours
- Air purification: ActivePure Technology

Coverage:

- Coverage: Up to 1000ft²*

Size:

- Dimensions: 16 4/5" high x 13" wide x 16 3/5" deep
- Weight: 22 pounds

Warranty

- 3 year limited Warranty.

Safety Protection:

- Overheat safety feature
- Tip-over safety feature
- Auto-lock feature

Other Features:

- Washable filter
- Remote control

When not in use, unit should be stored in a clean/dry environment (60 - 80° F (15 - 27° C)) and 50 - 60% RH.

SAFETY FEATURES

TIP-OVER SAFETY FEATURE

This heater is equipped with a tip-over safety feature. Once the heater is tipped over, an internal switch will automatically shut the heater off. Once the heater is restored an upright position, the heater will reset. To continue operation, turn on the heater using the supplied remote control or the control panel on the heater.

NOTE: It is normal for the power cord to feel warm to the touch; however, a loose fit between the outlet and the plug may cause overheating of the plug. If this occurs, try inserting the plug into a different outlet. Contact a qualified electrician to inspect the original outlet for damage.

IN THE BOX

- SafeHearth™ Portable Heating System
- Remote Control with battery installed
- Owner's Manual

OVERHEAT SAFETY FEATURE

This heater is equipped with a overheat safety feature. When the heaters internal components reach a certain temperature that could cause overheat and possible fire, the heater will automatically shut off.

AUTO-LOCK FEATURE

Auto-lock can prevent children from changing settings on the heater. It can be set with the unit either power on, to prevent changes to the temperature or fan setting, or power off, to prevent turning the unit on. When locked, control panel and remote control failed to function.

PRODUCT DIAGRAM

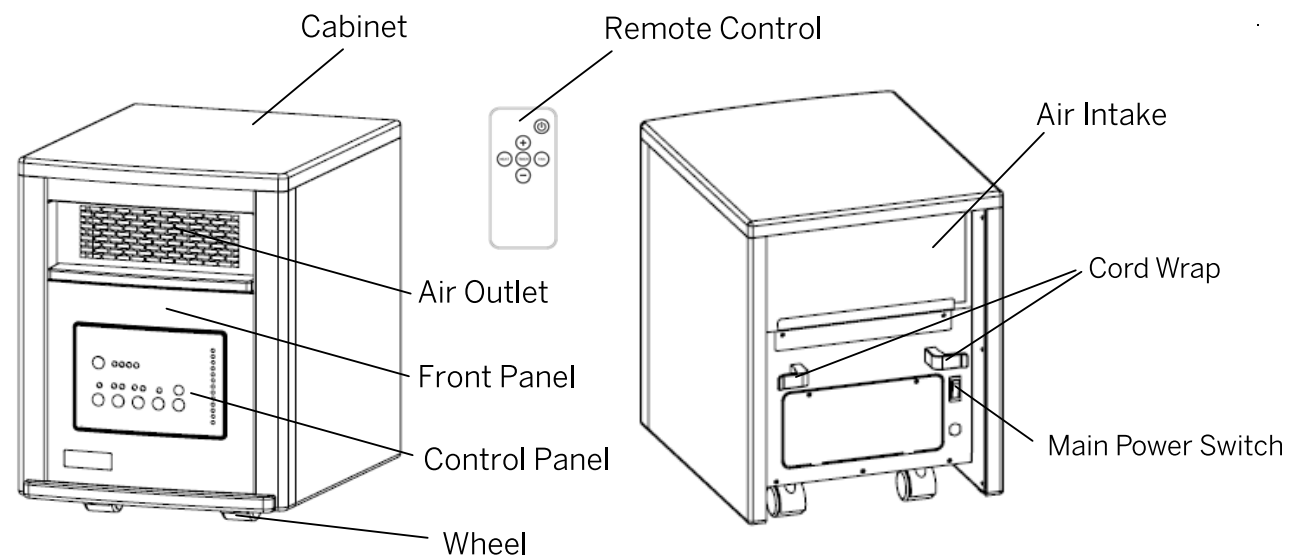

CONTROL PANEL

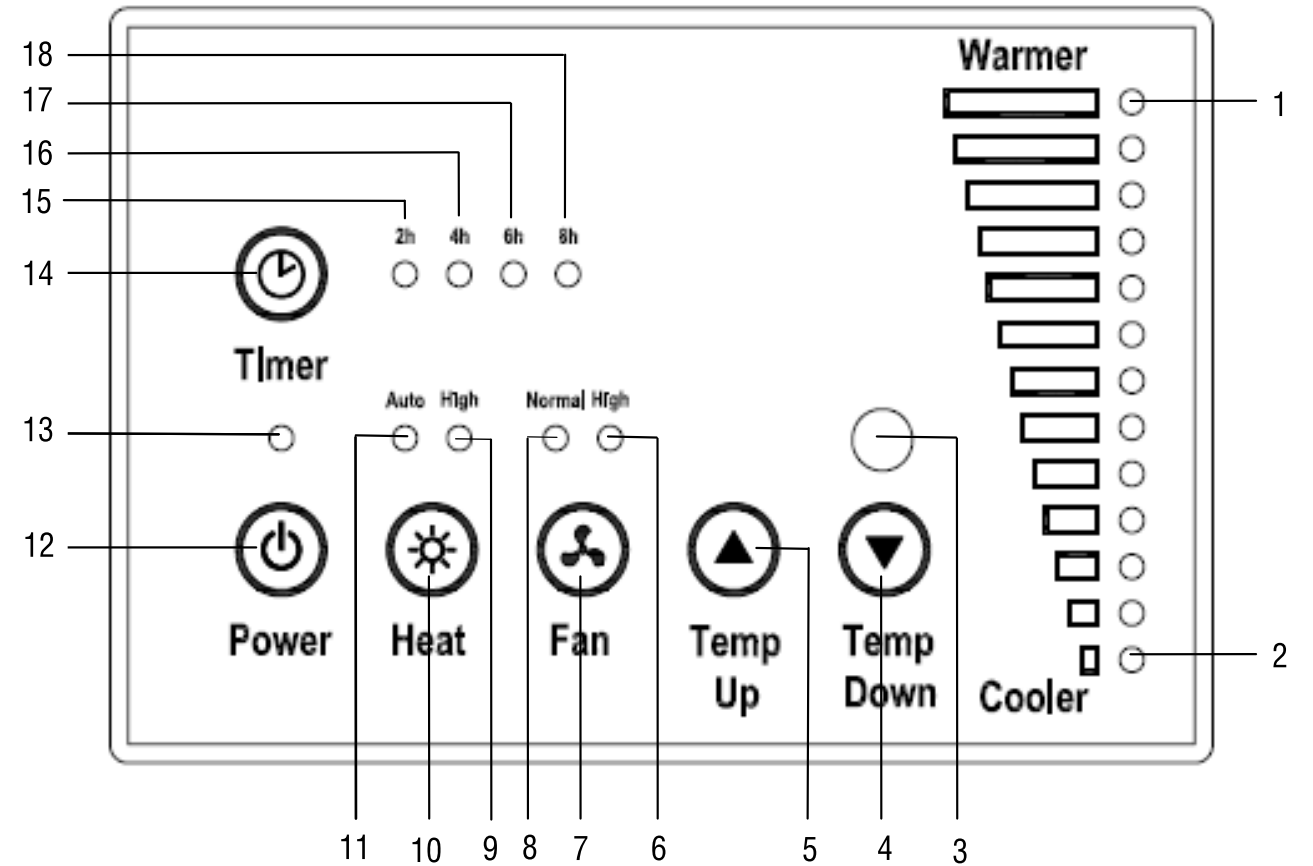

1. Maximum temperature indicator: all lights are on when set at the highest temperature
2. Minimum temperature indicator: bottom light is on when set at the lowest temperature
3. Remote control signal: window for receiving remote control signal
4. Temperature down button: for setting temperature lower
5. Temperature up button: for setting temperature higher
6. High fan speed indicator: light is on when high fan speed is selected
7. Fan speed button: for selecting fan speed
8. Normal fan speed indicator: light is on when normal fan speed is selected
9. High heat mode indicator: light is on when High heat mode is selected
10. Heat button for selecting either Automatic heat mode or High heat mode
11. Automatic heat mode indicator: light is on when Automatic heat mode is selected
12. Power button: for power on or off
13. Power supply light light is on when the unit is connected to electric supply
14. Timer button for adjusting the length of time unit runs and turning on the timer
15. 2 hours indicator: light is on when you set the timer for 2 hours
16. 4 hours indicator: light is on when you set the timer for 4 hours
17. 6 hours indicator: light is on when you set the timer for 6 hours
18. 8 hours indicator: light is on when you set the timer for 8 hours

REMOTE PANEL

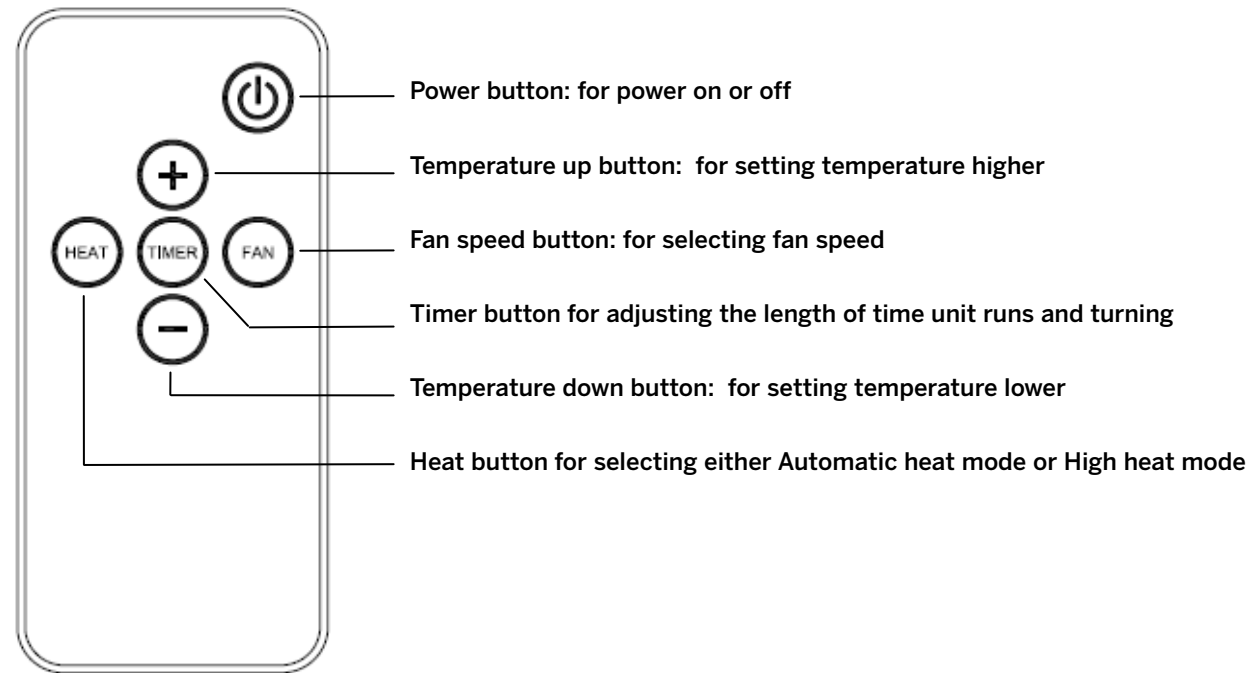

PREPARATION

Place the heater on a firm, level surface and plug into a grounded 120V 60Hz power outlet. Turn on the power switch in the rear of the unit. Only operate heater in an upright position with caster wheels attached.

When using remote control, please pull out the insulating film as illustrated below.

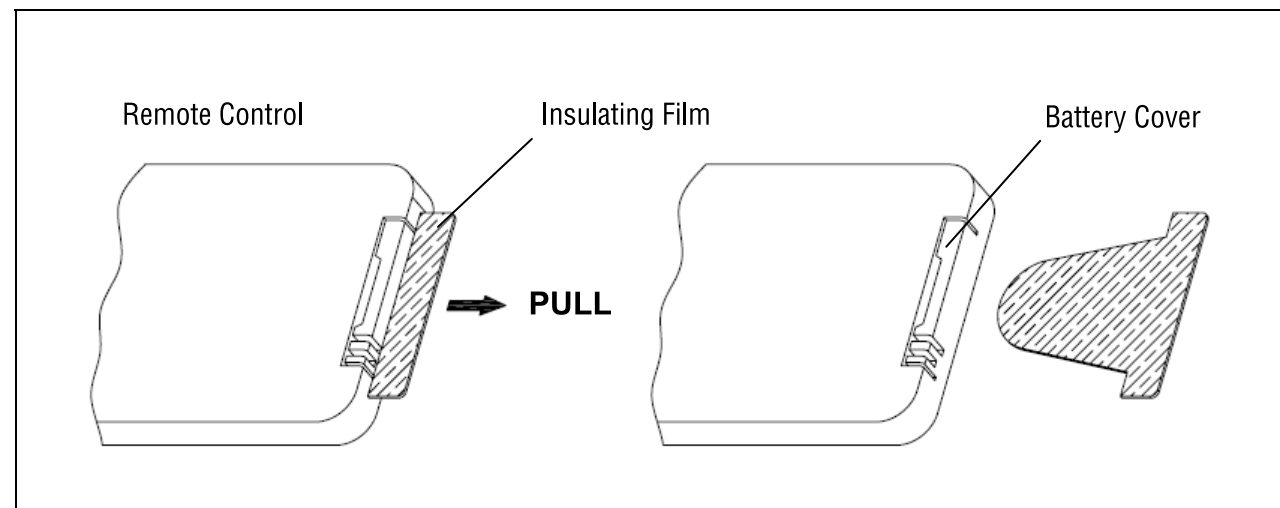

OPERATING INSTRUCTIONS

Start and select working mode



 Power Or	Turn the heater on by pressing the Power button on the control panel or by pressing the Power button on the supplied remote control.
 Heat Or	Select a heat setting. Press the Heat button to alternate between the two heat settings.
Auto High 	Automatic heat mode - user adjusts the temperature manually to desired level. High heat mode - Heater will operate at maximum output.
 Fan Or	Press Fan button either on the control panel or remote control to select fan speed. Choose either normal speed or high speed.
Normal High 	Use Normal speed for typical, consistent use. Use High speed to diffuse heat at an increased speed.

Setting room temperature

Caution: Temperature can only be set in Automatic heat mode.



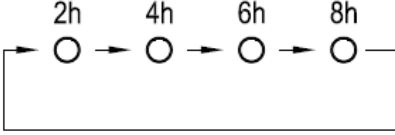

 Temp Down Or Or	Adjust the thermostat by pressing the arrows on the control panel or remote control.
	Once you have chosen the desired temperature, the heater will remain on until the room temperature increases to the set temperature. The heater will cycle on and off to maintain the desired room temperature.

SETTING THE TIMER

 <p>Timer Or </p>	<p>Press Timer button either on the control panel or remote control.</p>
	<p>Indicator lights signal the length of the timer. To set the length of time, press the Timer button continuously until the indicator of desired length lights. Timer will begin immediately. Timer can be set at a 2h-4h-6h-8h circulation. When all 4 lights are off, that indicates the timer is not set.</p>

SETTING THE AUTO-LOCK

Auto-lock can prevent children from changing settings on the heater. It can be set with the unit either power on, to prevent changes to the temperature or fan setting, or power off, to prevent turning the unit on. When locked, control panel and remote control failed to function.

 <p>Temp Down And </p>	<p>Press Temp Up and Temp Down buttons simultaneously and hold for 3 seconds. Unit is locked when a beep sounds. When locked, control panel and remote control failed to function.</p>
 <p>Temp Down And </p>	<p>To release the Auto-Lock feature, press Temp Up and Temp Down buttons simultaneously for 3 seconds. Unit is unlocked when a beep sounds. Lock indication disappears. Control panel and remote control return to normal function.</p>

MAINTENANCE

WARNING:

- Turn off the power switch in the rear of the unit.
- Unplug the unit and let it cool completely.

Unit Cleaning

- To keep the heater clean, the outer shell may be cleaned with a soft cloth.

CAUTION: DO NOT let liquid enter the heater. DO NOT put liquids inside the heater.

- DO NOT use alcohol, gasoline, abrasive powders, furniture polish, or rough brushes to clean the heater. This may cause damage or deterioration to the surface of the heater.
- DO NOT immerse the heater in water.
- Wait until the unit is completely dry before use

Air Filter Cleaning

NOTE: Always disconnect from power before removing filter for cleaning.

Air filter requires cleaning after every 3-6 months of use, or as needed. Please remove the filter following the steps below. Once removed, flush and clean the filter with water, then allow to air-dry completely before reassembling.

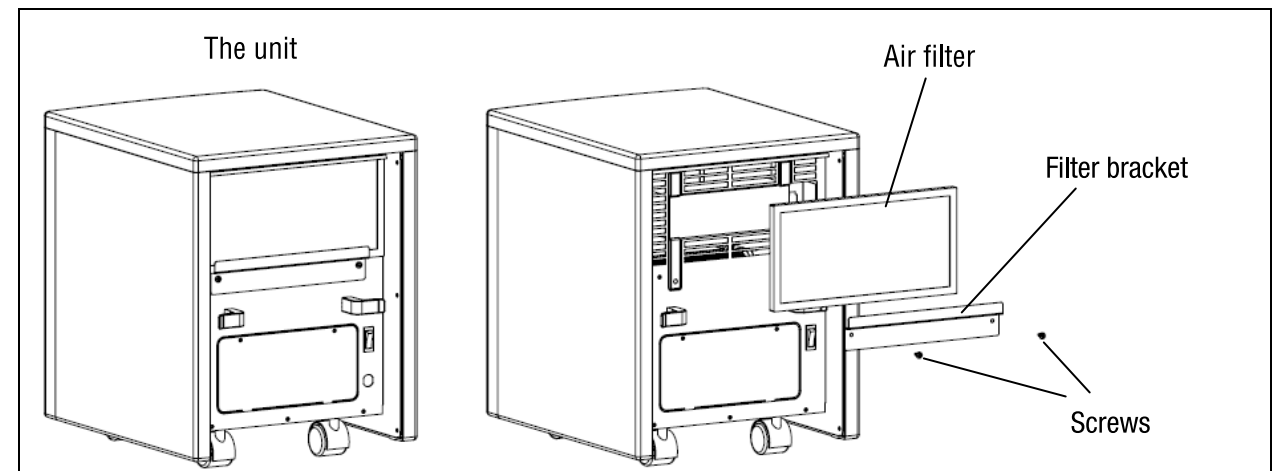

Remote Control Care

When remote control will not be in use for a long period of time, remove the battery according to the following steps.

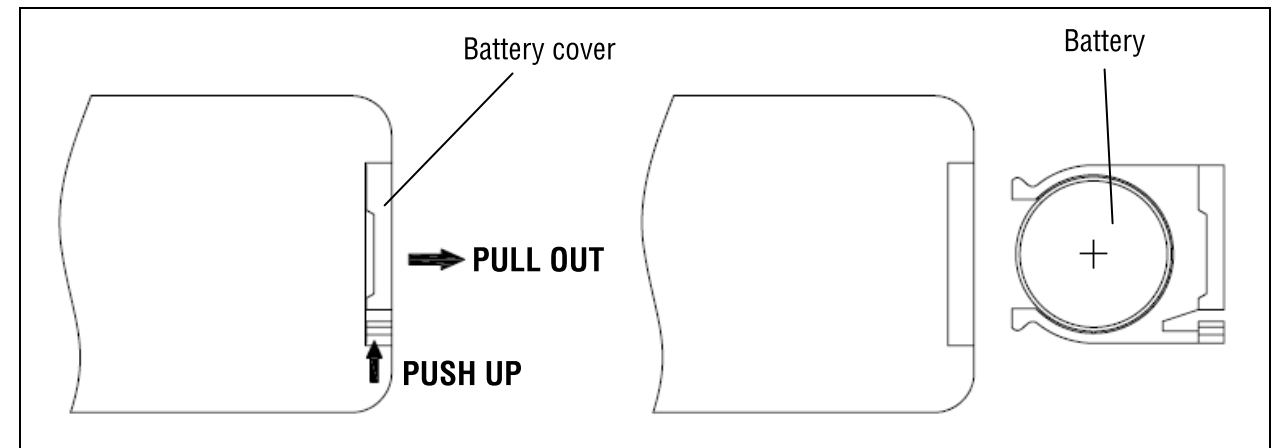

Push battery cover lock up then pull cover out as indicated in the diagram above. When replacing the battery, positive side faces up.

ACTIVEPURE CELL CLEANING AND REPLACEMENT

WARNING:

- Turn off the power switch in the rear of the unit.
- Unplug the unit and let it cool completely.

1. Remove the screws from the filter bracket on the back of the unit. Remove the bracket and air filter.
2. Using the tabs, lift out the ActivePure cell.
3. Disconnect the two pin connectors and remove the entire ActivePure assembly from the unit.
4. The ActivePure cell and filter can now be replaced or cleaned. To clean, carefully vacuum or brush the ActivePure cell and filter. The ActivePure cell should be cleaned whenever you clean the air filter, every 3-6 months or as needed.
5. If damaged, worn, or difficult to clean, replace the filter and/or ActivePure cell. ActivePure cell should be replaced every 2 years, or as needed.

For a replacement ActivePure Cell, or for replacement filters, contact your Vollara Distributor for more information.

6. Reassemble the ActivePure cell, by connecting the two pin connectors and sliding into place. Reassemble the filter, back cover, and holder assembly as shown.

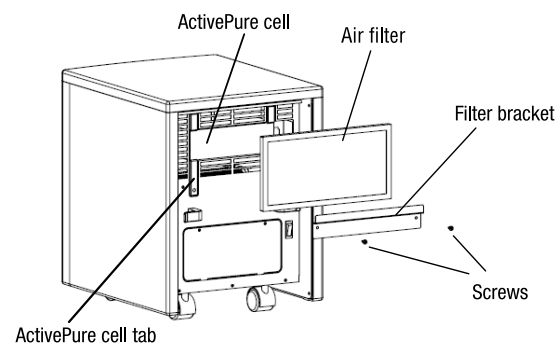
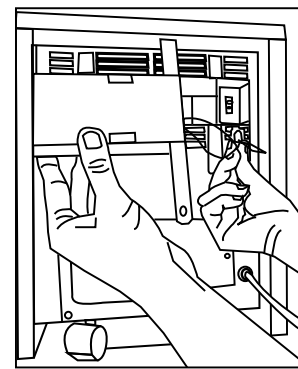
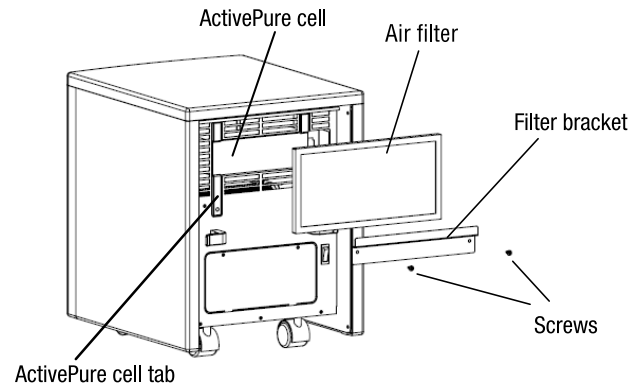

WARNING! - The filter and ActivePure Cell must be properly installed. DO NOT OPERATE THIS APPLIANCE WITH THE FILTER REMOVED. Failure to follow these instructions may result in exposure to UV light or personal injury.

7. Reconnect power

STORAGE

Store the heater in a cool, dry location when not in use. To prevent dust and dirt build-up, use the original packaging to repack the unit.

TROUBLESHOOTING

If the heater will not operate, please check the following before calling for repair:

1. Check if the power cord is plugged into an electrical outlet, if not, plug in.
2. Check the outlet for electricity.
3. Check that main power switch on rear is on. Switch will illuminate when on.
4. Check if the battery in remote control is operational, and if the insulating film is removed.

NOTE: The heater may not be operating if the thermostat is set lower than the room temperature. To begin operation, increase the thermostat temperature for a higher heat setting.

LIMITED THREE YEARS WARRANTY

Terms: - Vollara technology products with valid serial numbers are under warranty by Vollara, LLC, 300 East Valley Drive, Bristol, VA 24201 (the "Company"), to the original purchaser only, to be free from defect in materials and workmanship for three (3) years from date of purchase. If a valid serial number is missing from a product, the warranty will be voided. To confirm warranty coverage prior to purchasing a product, contact the Company at 800.989.2299 with the serial number located on the back of the unit.

Vollara products are authorized for sale through Independent Dealers only. Warranties are voided if a product is purchased through unauthorized channels. The Company will not extend warranty coverage on any product sold in a manner that violates our Internet Advertising Guidelines. This includes websites that are not authorized to use our trademarked names, images, and logos, as well as Internet auction sites. The only approved Internet presence for Vollara products are the Company's corporate web addresses, www.Vollara.com.

The Company's liability under this Warranty shall be limited to repair, or at our option, replacement without charge, except for transportation. All transportation charges on parts or units submitted under this Warranty shall be borne by purchaser. Unless this Warranty is expressly renewed or extended by the Company, any repaired or replaced part of the unit shall be under warranty to the original purchaser only, for the length of the unexpired portion of the original warranty.

Products which are returned for a repair after the warranty period, do not have a valid serial number and thereby a voided warranty, or which show damage for which the Company is not responsible, will be repaired for a reasonable charge. The Company will advise purchaser of the cost before proceeding. This Warranty shall not apply to any unit which in the Company's reasonable judgment has been subject to alteration, misuse, negligence or accident, or damage resulting from improper service by a person not authorized by us to perform such work, or from usage with any but the specified voltage, or any product without a valid serial number.

The Company makes no warranties, express or implied, with respect to our Products, except such written warranty or warranties as may be set forth herein. SUCH WRITTEN WARRANTY IS EXCLUSIVE AND, TO THE EXTENT PERMITTED BY LAW, the company DISCLAIMS ALL OTHER WARRANTIES, INCLUDING BUT NOT LIMITED TO A WARRANTY OF MERCHANTABILITY OR FITNESS OF PURPOSE. NO CONSEQUENTIAL DAMAGES,

INCIDENTAL DAMAGES OR OTHER INDIRECT OR SPECIAL DAMAGE OR LOSS, SUCH AS, BUT NOT LIMITED TO, LOSS OF PROFITS, LOSS OF GOODWILL, LOSS OF BUSINESS OPPORTUNITY, LOSS OF USE OF PLANT OR EQUIPMENT, OR LOSS OF EXECUTIVE AND EMPLOYEE TIME, WILL BE RECOVERABLE AND ARE SPECIFICALLY DISCLAIMED. THIS LIMITATION OF LIABILITY AND REMEDY REPLACES ANY AND ALL THEORIES OF ACTION, CAUSES OF ACTION, OR THEORIES OF DAMAGE WHICH MAY BE HAD OR BROUGHT, INCLUDING BUT NOT LIMITED TO ACTIONS BASED ON STATUTE, CONTRACT, BREACH OF WARRANTY, NEGLIGENCE, STRICT LIABILITY OR OTHER TORT THEORY. Some states do not allow the exclusion or limitation of incidental or consequential damages, so the above limitation or exclusion may not apply to you.

This Warranty gives you specific legal rights, and you may also have other rights, which vary from state to state. If your unit is defective, please contact the Company at 300 East Valley Drive, Bristol, VA 24201 or www.Vollara.com.

Mail Warranty Card Information to the Company or register online within 10 days of purchase for activation of warranty.

FCC DECLARATION OF CONFORMITY

Name: Vollara, LLC

Model: SafeHearth™

This device complies with Part 15 of the FCC Rules.

RESPONSIBLE PARTY

Vollara, LLC

300 East Valley Drive
Bristol, VA 24201
(800)989-2299



Printed Name: Andrew Eide

Title: Vice President Product Development & Research

Date: 8/1/10

This equipment has been tested and found to comply with the limits for Industrial, Scientific, and Medical Equipment (ISM), pursuant to Part 15 of the FCC Rules. These limits are designed to provide reasonable protection against harmful interference in a residential installation. This equipment generates, uses, and can radiate radio frequency energy, and if not installed and used in accordance with the instructions, may cause harmful interference to radio communications. However, there is no guarantee that interference will not occur in a particular installation. If this equipment does cause harmful interference to radio or television, which can be determined by turning the equipment off and on, the user is encouraged to try to correct the interference by one or more of the following measures:

Reorient or relocate the receiving antenna.

Increase the separation between the equipment and receiver.

Connect the equipment into an outlet on a circuit different from that to which the receiver is connected.

Consult the Distributor or an experienced radio/TV technician for help.

Vollara, LLC

5420 LBJ Freeway Suite 1010
Dallas, TX 75240
(800)989-2299
www.vollara.com



©2010 Vollara, LLC. All rights reserved.