

# EAGLE 5000

## OWNER'S MANUAL

- Application
- Notable Features
- Specifications
- Installation
- Operation
- Maintenance
- Warranty

---

## ELECTRONIC AIR PURIFICATION SYSTEM

---

*100, 120, 220 and 240 volt Systems*



### EcoQuest International

310 T. Elmer Cox Drive  
Greenville, TN 37743  
(888)664-1812

**CAUTION:** read manual carefully for proper procedures and operation.

# CONTENTS

---

Specifications .....	3
Introduction .....	4
Features ..	4
Applications .....	4
Installation .....	5
Lint Screen & Carbon Filter Removal .....	6
SynAirG™ Purification Plate Installation.....	7
Carbon Filter Installation.....	8
Lint Screen Installation .....	8
Placing the Unit .....	9
Settings and Adjustments .....	10
Maintenance.....	11
Changing the Fuse.....	12
Troubleshooting.....	12
Warranty Information.....	15

Please record the name and phone of your EcoQuest Dealer:

Name \_\_\_\_\_

Phone \_\_\_\_\_

Please record the serial number of your Eagle 5000:

Serial # \_\_\_\_\_

This owner's manual is also available online at: <http://www.ecoquest.com/ownersmanuals>

**Features:**

- Positive/Negative Ion Generation Technology.
- Adjustable Ozone Generation.
- Activated Charcoal Deodorization.
- Adjustable fan speed control.
- Washable permanent lint screen.
- Adjustable ozone control and plate configuration.
- Adjustable ion control.

**Electrical:**

- 100 volt 50/60hz, 120 volt 60hz, 230 volt 50/60 hz or 240 volt 50 hz.
- Less than 60 watts power consumption.
- 24 to 30 KV, 20-30 khz ion generation pulsator.
- 20 KV negative ion generator.

**Mechanical:**

- 550 CFM

**Size:**

- Dimensions: 15.5" high x 12" wide x 12 3/4" deep
- Weight: 35 pounds

**Ozone Output:**

- 140-420 mg per hour (depending on the number of plates installed).

**Warranty:**

- Length of warranty will vary depending on model.
- See warranty card for specific details.



To reduce the risk of electric shock, this equipment has a grounding type plug that has a third (grounding) pin. This plug will only fit into a grounding type power outlet. If the plug does not fit into the outlet, contact qualified personnel to install the proper outlet. Do not alter the plug in any way.



**WARNING!** - Do not operate this unit without one or all SynAirG™ purification plate(s) properly installed. Doing so may void the warranty.



**CAUTION!** - Disconnect power cord before servicing.  
100 and 120 volt models - use 1.6 Amp slow blow fuse.  
220 and 240 volt models - use 0.5 Amp slow blow fuse.



---

Location for Protective Earth Line.

---

## INTRODUCTION

---

Nature cleanses the air with the lightning and rain. Lightning bolts produce ozone, as well as positive and negative ions which cleanse the air naturally. Rain helps bring the ozone and ions closer to the earth's surface. They are then attracted to atmospheric contaminants that are either removed from the air and attached to grounded objects or are oxidized.

The Eagle 5000 reproduces the natural conditions found in the outdoors. It is not designed to create an artificial environment. The re-establishment of a natural environment takes place out in the air, rather than inside the unit. It cleanses the air, rather than filtering it, masking the symptoms, or attempting to dilute it.

## FEATURES

---

- Compact
- Portable
- No Duct work Required
- No Chemicals
- Low Maintenance
- Low Electrical Usage
- Complete User Control
- No Residual Contamination

## APPLICATIONS

---

- Restaurants
- Smoking Areas
- Produce Areas
- Basements
- Veterinary Offices
- Casinos
- Large Meeting Halls
- Kennels
- Stables & Barns
- Photo Labs
- Salons
- Day Care Centers
- Chemical Odors
- Bowling Alleys
- Bingo Parlors

# INSTALLATION

---

1. Remove unit from shipping carton.
2. Remove all protective materials.
3. Check for shipping damage and loose or broken parts.
4. Read Owners Manual thoroughly prior to installation.
5. Remove SynAirG™ purification plates from the box and install (page 6).
6. Install the internal carbon filter (page 8).
7. Install the rear lint screen (bottom of page 8).
8. Fully insert cord into the power cord receptacle on the back of the unit.
9. Determine placement location for the unit (page 9), plug the unit into a 120 volt, 100 volt, 220 volt or 240 volt (depending on model) outlet, be sure the power switch is on, and adjust controls according to the application.

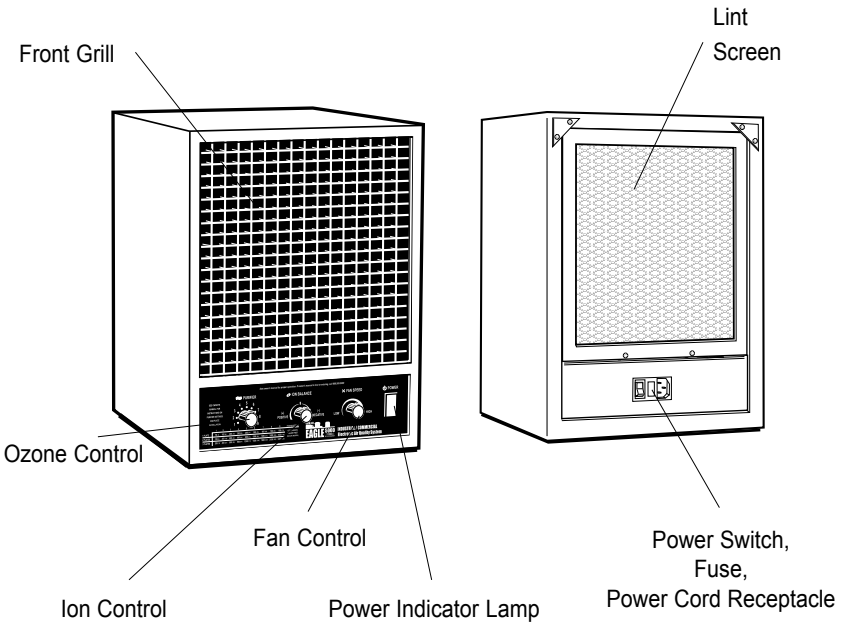

# LINT SCREEN & CARBON FILTER REMOVAL

---

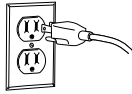

1. Unplug the Eagle 5000 to prevent electric shock.

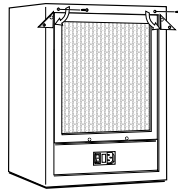

2. Remove only one screw from each of the 2 top corner brackets and rotate bracket out of the way.

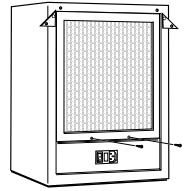

3. Remove 2 screws from bottom of lint screen.

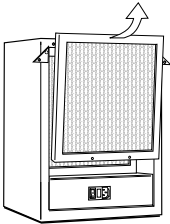

4. Pull top of lint screen toward you, then lift out.

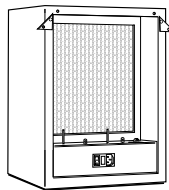

5. Once the lint screen is removed, the carbon filter may be removed also.

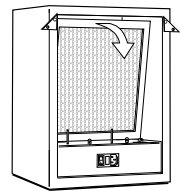

6. Using the plastic tab, pull the top of the carbon filter towards you.

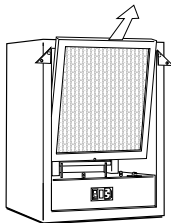

7. Pull the carbon filter out of the unit.

# SYNAIRG™ PURIFICATION PLATE INSTALLATION

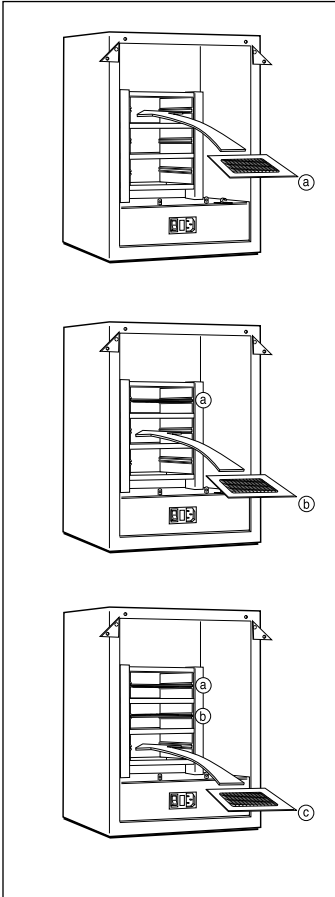

1. Remove the rear lint screen and the internal carbon filter (see page 6).

2. After determining the square footage (use the formula  $\text{SQUARE FEET} = \text{LENGTH} \times \text{WIDTH}$ ) use the Purifier Setting chart (below or on the faceplate of the unit) to determine the correct number of plates to install.

3. Fully insert the needed SynAirG™ purification plates (a,b,c) between the guide-grooves in the sides of the plate cage (between the posts and clips) making sure the metal clip on each side of the plate is in contact with the metal screen on the plate.

4. Replace the carbon filter and reinstall the rear lint screen (page 8).

	1	2	3	4	5	6	7	8	9	PURIFIER SETTING
1 PLATE	50 (4)	100 (9)	200 (19)	300 (28)	400 (37)	500 (46)	600 (56)	700 (65)	800 (74)	COVERAGE IN SQUARE FEET (SQUARE METERS)
2 PLATES	100 (9)	200 (19)	400 (37)	600 (56)	800 (74)	1000 (93)	1200 (111)	1400 (130)	1600 (149)	
3 PLATES	200 (19)	400 (37)	600 (56)	900 (84)	1200 (111)	1500 (139)	1800 (167)	2100 (195)	2400 (223)	

# CARBON FILTER INSTALLATION

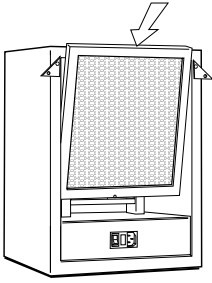

1. Always install carbon filter bottom first.

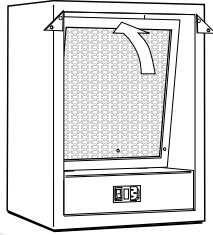

2. Once the bottom of the filter is in place, insert the top of the filter into the case.

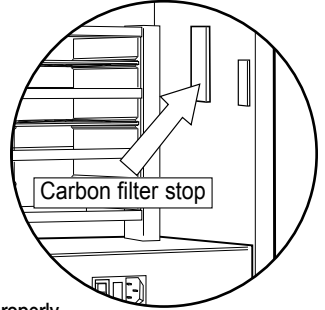

3. When properly installed, the carbon filter fits against the internal stops located on the left and right insides of the case.

# SCREEN INSTALLATION

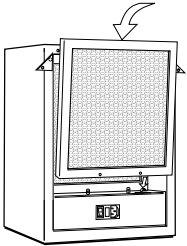

1. Always install carbon filter bottom first.

2. The bottom of the lint screen should depress the safety switch arm towards the bottom of unit.

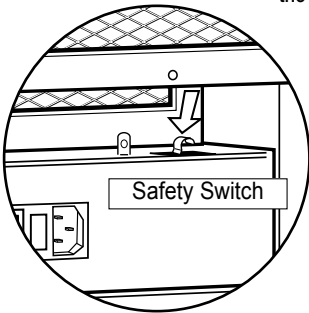

3. Insert 2 screws at bottom of lint screen (do not overtighten screws).

4. Fit top of lint screen into cabinet, rotate 2 corner brackets and secure with screws.

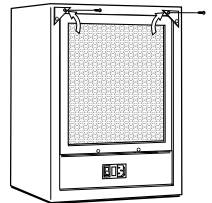
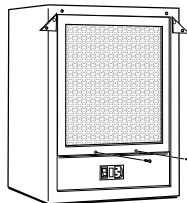



## PLACING THE UNIT

---

Place the unit as high as possible to insure complete purification.

If raised placement is not available, place unit as high as possible and elevate front of unit so fan blows towards ceiling. Some pollutants such as smoke will rise and the unit, when elevated, can oxidize the pollutants more effectively. A ceiling fan can also aid in distribution of cleansing properties.

The Eagle 5000 is most effective when placed in a position that allows the ions and ozone to be mixed evenly and thoroughly with the polluted air.

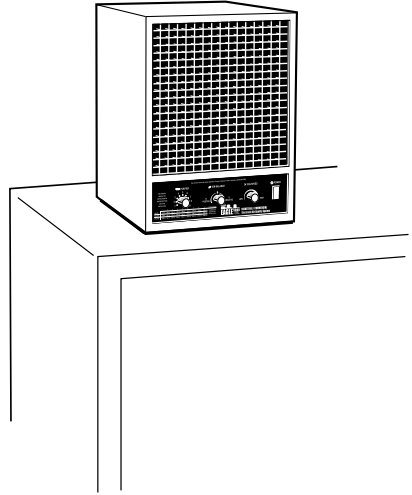

### *Suggested locations, listed in the order of preference:*

1. Nearest the source of the worst pollution.
2. Near a cold-air return to thoroughly circulate clean air throughout the area.
3. In the area most heavily used to achieve maximum benefit.

### *Note:*

- For maximum control the unit should be placed where easy access to the controls is possible.
- The rear of the unit should always have at least one inch of open area to allow unrestricted airflow.
- Be sure power cord is not accessible to small children to prevent injury.

---

**Caution:** *This unit should never be placed where it can blow directly into the face of any person or pet.*

---

# SETTINGS AND ADJUSTMENTS

---

## 1. FAN CONTROL

The disbursement of cleansing properties is best accomplished with good air circulation. The fan control should be set as high as reasonably possible without creating an undesirable noise level. This will be determined by personal preference and the distance you wish the cleansing properties to be dispersed.

*Note: A ceiling fan can also aid in distribution of cleansing properties.*

## 2. PURIFIER CONTROL

PURIFIER Control: Set the control at the nine o'clock position for one hour.

Adjust the control up or down after one hour based on the following criteria:

1. In normal conditions it is not necessary to turn the PURIFIER control indicator above the area of the environment. (*refer to purifier chart on page 7*)
2. Keeping in mind the previous statement (#1), adjust the purifier so that the odor of ozone fades into the background 15-30 seconds after entering the environment.

## 3. SANAIR FEATURE

To reduce mold, mildew, and bacteria, turn the unit on high for 3-4 hours.

---

**Caution:** Always be sure a room or area is **UNOCCUPIED** before performing the above described SanAir procedure.

---

Air out room by opening door and/or window.

## 4. ION CONTROL

The normal setting of a DC ionizer is full negative. This setting seems to work best in removing particulate (cigarette smoke) as well as reducing static. When trying to reduce static, if the full negative setting results in more static, turn the ion control in small increments towards the positive until the static is relieved.

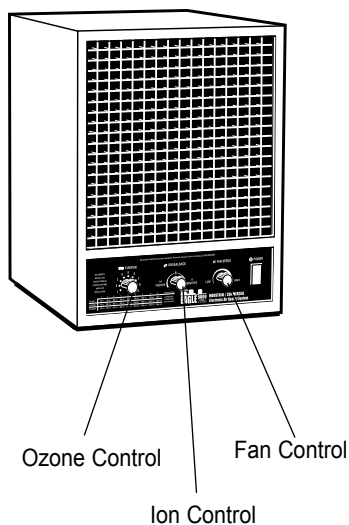

## MAINTENANCE

Periodic maintenance is required to insure that the Eagle 5000 operates properly. A severely polluted environment can foul an SynAirG™ purification plate in as little as two weeks or as long as a year. Shown here are basic maintenance procedures that should be carried out to keep your unit running at top performance.

### ***Rear lint-screen / carbon filter cleaning (see page 6 for removal instructions):***

You have two options to clean the lint screen and carbon filter:

- When visibly dirty, simply remove the lint screen or carbon filter and with a hand-held vacuum remove the heavy particulate from the screen. This method will extend the life of the screen / filter.

- OR -

- When visibly dirty, remove the lint screen or carbon filter from the unit and wash in hot water, brushing gently with a toothbrush to remove particulate. Allow to dry completely prior to re-installing the lint screen.

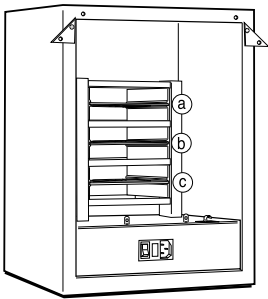

### ***SynAirG™ purification plate***

Remove the rear lint screen (page 6).

Carefully remove the SynAirG™ purification plates (a, b, c).

Clean the plates (a, b, c, & d) with hot water and ammonia. Dry completely using a hair dryer if necessary. Reinstall plates (page 7). Be sure to check that the electrical tabs are in contact with the plate.

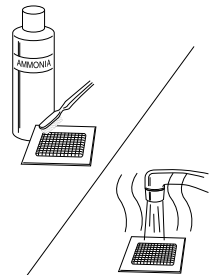

### ***Plate Card Cage***

Also be sure to clean the stand-offs at the corners of the plate card cage. (A cotton swab with alcohol works well.)

### ***Fan Blade and Front Grill***

Wipe off fan blade and front grill (if dirty) with damp washcloth. The fan requires no maintenance (with the exception of the first time it is used, when it may be necessary to give it a gentle push to get it started). If the fan squeaks, a drop of lightweight oil may be needed on the fan shaft.

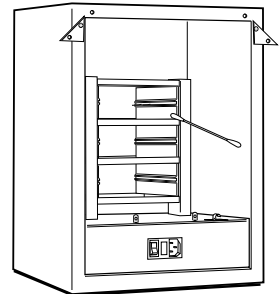

## CHANGING THE FUSE

---

A fuse holder is located on the back of the unit next to the power cord. To replace or check the fuse, remove the fuse holder by pressing on the release catches and pulling straight out.

If the fuse is blown, replace with a new slow blow type fuse. Insert the new fuse into the fuse holder. Press the assembly straight in until it latches.

*If the fuse holder cap is not installed correctly, the unit will not operate.*

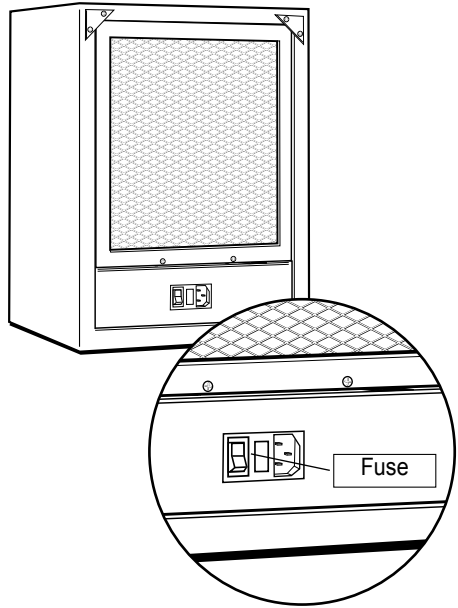

---

**100 and 120 Volt Use 1.0 AMP slow blow fuse.**  
**220 and 240 Volt Use 0.5 AMP slow blow fuse.**

---

## TROUBLESHOOTING

---

### *Indicators of Operation*

Operation of the ion indicator lamp:

Turn the unit on and check that the small red/orange lamp is illuminated. The lamp is located inside the unit and is viewed by looking into the unit through the front grill. Illumination of the internal lamp verifies that the frequency type ionizer is functioning properly. The lamp should stay illuminated as long as the unit is turned on.

## **Troubleshooting - What to look for first.**

### ***1. I have plugged in the unit, turned "ON" the power switch and nothing happens...what's wrong?***

- Make sure the electrical outlet is capable of providing power to the unit.
- Check the lint screen located at the back of the machine to ensure that the safety switch activator clip depresses the safety switch.
- Check to see if the proper fuse is installed and that it is serviceable.
- Ensure that the fuse cap is completely seated and secured in its receptacle.
- Be sure the cord is fully plugged into unit.

### ***2. The fan is operating although the unit won't produce any ozone...what's wrong?***

- Check the SynAirG™ purification plate(s) for serviceability. If they are cracked or broken, the plate(s) will require replacement. Ensure maintenance procedures required for the SynAirG™ purification plate(s) have been performed according to the "Maintenance" section (page 11) of this Owner's Manual. Order new plates from your Dealer.
- Electrical stainless steel contacts are not contacting the screen portion of the SynAirG™ purification plate(s). Inspect the unit for any loose connections.
- Do not attempt to disassemble the unit, due to the Limited Warranty of the product.

### ***3. How am I able to know if the Frequency-Type Ionizer is working?***

- Current models with the FT Ionizer system have a neon light bulb mounted on the base of the FT antenna. When the power switch to the unit is turned ON, the neon light bulb will illuminate, indicating that the FT Ionizer is functioning normally (see page 12, "Indicators of Operation").

### ***4. The SynAirG™ purification plate(s) are making a noise, have a burning smell, and/or appear to arc or spark. What is the problem?***

- SynAirG™ purification plate is most likely cracked. Refer to the answers for question #2, as it would apply to this question also.

### ***5. What are the most typical application problems?***

- **Symptom:** A belief that the proper equipment is placed in the environment and the equipment appears unsuccessful.

Problem: Lack of air movement, improper placement of the unit.

- **Symptom:** Strong odors still remain with the environment after placement.

Problem: Lack of ozone, improper placement of the unit.

- **Symptom:** A strong odor of ozone is present within the environment.

Problem: Too much ozone accumulation within the environment, as a result of improper purifier control setting, and / or lack of air movement.

- **Symptom:** Visual haze of smoke and / or particulate remain within the environment.

Problem: Lack of ionization and / or air movement.

### ***6. Unit does not operate -***

- Is the unit plugged in?
- Is the power cord fully inserted into the back of the unit?
- Are you sure the outlet is active?
- Is the unit turned on?
- Is the rear lint screen installed properly to depress the safety switch forward?

### ***7. Air flow is restricted or reduced -***

- Is the unit properly placed away from objects that may obstruct air flow?
- Are the filter and fan housing clean?

If your unit fails to operate properly after performing trouble-shooting, contact your EcoQuest Dealer for further assistance, contact us at the address located on the front of the manual, or visit [www.EcoQuestintl.com](http://www.EcoQuestintl.com) for additional technical support.

***Did you forget to register your Eagle 5000?***

By registering, you'll activate your warranty, and your privacy is guaranteed. Just fill out your warranty card and drop it in the mail.

**WARRANTY INFORMATION**

This product is of solid state construction and is warranted by

EcoQuest International  
310 T. Elmer Cox Drive  
Greeneville, TN 37743

to the original purchaser, depending on model, to be free from defect in materials and workmanship for a limited time.

Length of warranty will vary depending on model. See warranty card for specific details.

If you have any questions concerning your Eagle 5000, please see your local EcoQuest Dealer.

For help, visit [www.EcoQuest.com](http://www.EcoQuest.com)

This equipment has been tested and found to comply with the limits for Industrial, Scientific and Medical Equipment (ISM), pursuant to Part 18 of the FCC Rules. These limits are designed to provide reasonable protection against harmful interference in a residential installation. This equipment generates, uses and can radiate radio frequency energy and, if not installed and used in accordance with the instructions, may cause harmful interference to radio communications. However there is no guarantee that interference will not occur in a particular installation. If this equipment does cause harmful interference to radio or television, which can be determined by turning the equipment off and on, the user is encouraged to try to correct the interference by one or more of the following measures:

Reorient or relocate the receiving antenna.

Increase the separation between the equipment and receiver.

Connect the equipment into an outlet on a circuit different from that to which the receiver is connected.

Consult the dealer or an experienced radio/TV technician for help.

**FCC DECLARATION OF CONFORMITY**

**Name:** EcoQuest

**Model:** Eagle 5000

**Manufacturer:** EcoQuest Manufacturing

This device complies with Part 18 of the FCC Rules.

**RESPONSIBLE PARTY**

EcoQuest International  
310 T. Elmer Cox Dr.  
Greeneville, TN 37743

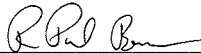
**Signature:** 

**Printed Name:** R. Paul Beam

**Title:** Engineering Manager

**Date:** 7/9/04

---

# *Eagle 5000™*

*Electronic Air Purification 100, 120, 220 and 240 volt Systems*

---



**EcoQuest International®**

310 T. Elmer Cox Drive

Greeneville, TN 37743

(888)664-1812

[www.ecoquest.com](http://www.ecoquest.com)